

ZyAIR B-5000

Outdoor Access Point & Bridge

Quick Installation Guide

Version 1.5.8.200

April 2004



Table of Contents

1	Introducing the ZyAIR	2
2	Applications	3
2.1	Access Point Application	3
2.2	Wireless Bridge Application	4
3	Connections	5
3.1	Outdoor Access Point & Bridge and Inline Power Injector Ports	5
3.2	Outdoor Access Point & Bridge Bottom Panel Connections	6
3.3	The Inline Power Injector Back Panel	7
3.4	The Inline Power Injector Front Panel	7
3.5	Making the Connections	8
4	Hardware Installation	10
4.1	Antenna Mast/Antenna Requirements	10
4.2	Grounding	11
4.3	What is Lightning Protection?	11
4.4	Why is Additional Protection Recommended?	11
4.5	Unpacking the ZyAIR	11
4.6	Mounting the ZyAIR	12
4.7	Power Connections	14
4.8	Attaching Antennas	16
5	Troubleshooting	18

1 Introducing the ZyAIR

The following Quick Installation Guide gives information on the hardware connections and mounting of your ZyAIR B-5000.

The ZyAIR Outdoor Access Point & Bridge provides excellent wireless performance. The ZyAIR extends the range of your existing wired network without any additional wiring efforts. The ZyAIR gives you the flexibility of being able to use one device for either of these powerful functions.

- As an Access Point (AP), the ZyAIR can be used to allow wireless stations to access your wired LAN. The ZyAIR also offers highly secured wireless connectivity to your wired network with IEEE 802.1x, WEP data encryption and MAC address based access control. It is perfect for providing outdoors broadband Internet access. The excellent RF performance means that the users do not need to be inside the same building or even in the same block.
- The ZyAIR can also function as a bridge or router to provide a wireless backbone connection between two or more buildings.

Rugged die-cast, watertight construction, built-in lightening protection, and grounding make the ZyAIR perfect for outdoors applications.

It is easy to install and configure the ZyAIR. The embedded web-based configurator includes a wireless link test that helps you to align the device. The web-based configurator and SNMP network management feature allows remote configuration and management of your ZyAIR. The Power over Ethernet (PoE) feature means that power can be delivered to the ZyAIR over an Ethernet line. This allows you to mount the ZyAIR in areas where there are no nearby power sources.

The following chapter introduces application examples of what you can do with your ZyAIR.

2 Applications

Here are application examples for your ZyAIR.

2.1 Access Point Application

Internet Service Providers (ISPs) can use the ZyAIR (Z) to provide wireless Internet access to users that are outdoors or in different buildings. A company with many employees working outdoors can also use the ZyAIR to extend the existing network without expensive network cables. Wireless stations can move freely anywhere in the coverage area and use resources on the wired network (see *Figure 1*). The ZyAIR is connected to an antenna, through an inline power injector (P) and through a hub, switch or router to the network.

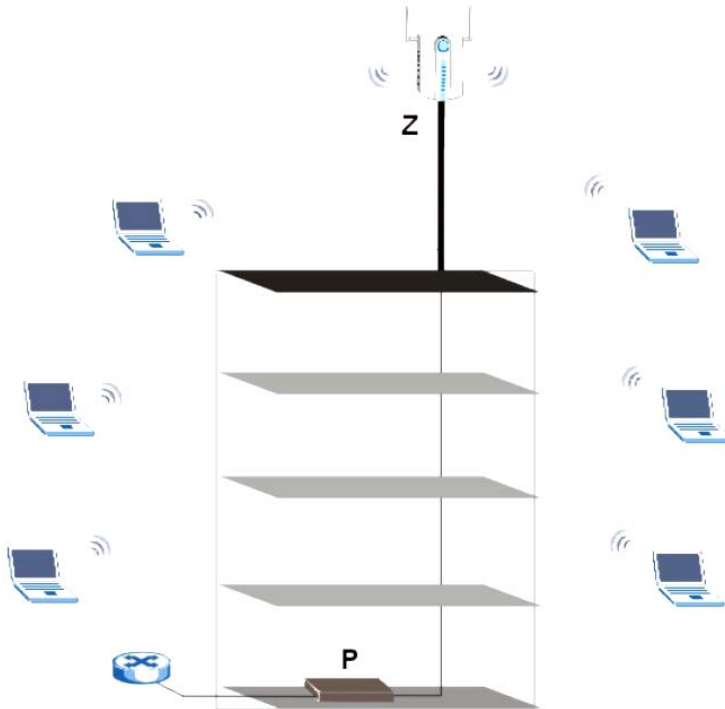

Figure 1 - Access Point Application

2.2 Wireless Bridge Application

You can use the ZyAIR as a bridge or router to form a wireless point-to-point or point-to-multipoint backbone connection.

With the bridge mode, you configure each ZyAIR to act as either a central bridge or a remote bridge. For point-to-multipoint applications, all communications between network systems go through the central bridge. See *Figure 2* for an example. The headquarters ZyAIR is the CB (central bridge). The ZyAIRs A and B are remote bridges at branch offices. The CB ZyAIR routes or bridges all communications between the ZyAIRs. The ZyAIR is connected to an antenna, through an inline power injector (P) and through a hub, switch or router to a network.

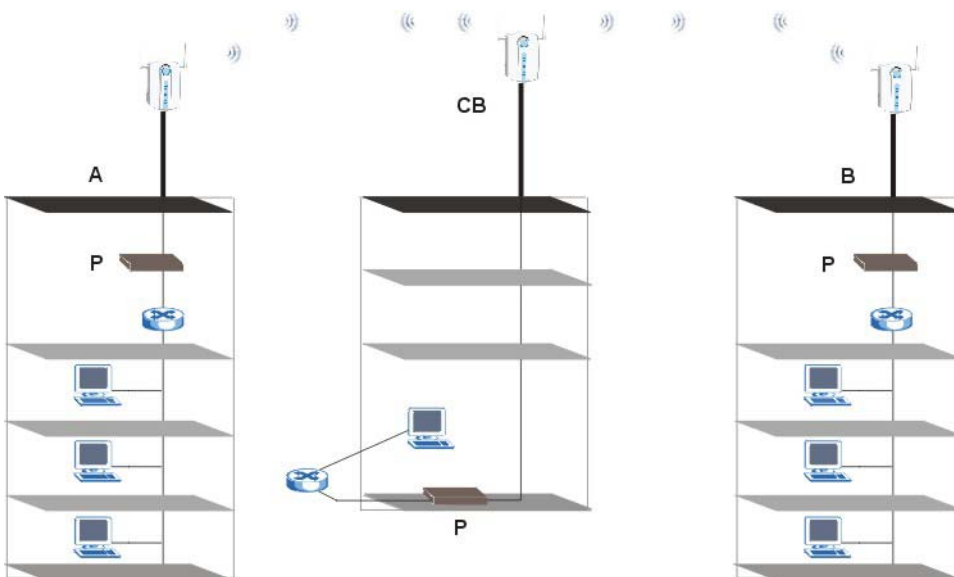

Figure 2 - Wireless Bridge Application

Please see the section on example scenarios in *Part I* and *IV* of the *ZyAIR User's Guide* for more information on network topologies.

3 Connections

The following section introduces the hardware connections for the ZyAIR.

3.1 Outdoor Access Point & Bridge and Inline Power Injector Ports

1. This is the special Ethernet port for connecting the MIL-C-5015 style Ethernet cable.
2. This is the special serial port for connecting the MIL-C-5015 style RS-232 console port cable.
3. This is the grounding port

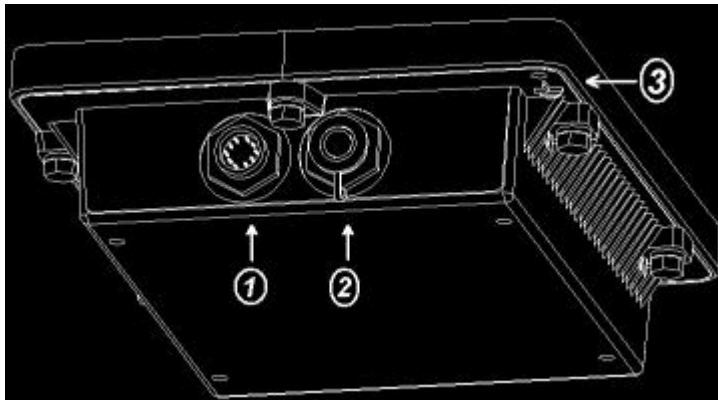

Figure 3 - ZyAIR Hardware Casing

4. These are the special N-Type connectors for connecting the antenna or an RF cable.
5. The **POWER & DATA OUT** port on the inline power injector is used for connecting the other end of the MIL-C-5015 style Ethernet cable.
6. The **DATA IN** port on the inline power injector is used for connecting the Ethernet cable to a hub, switch, router or a computer.

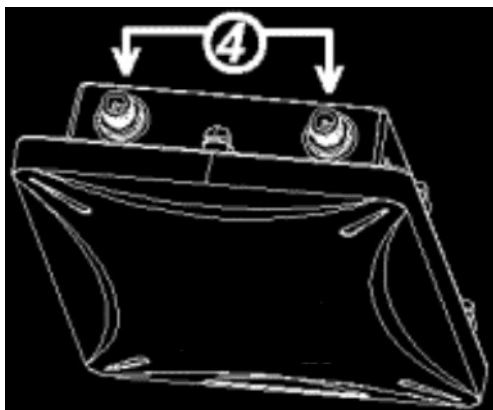

Figure 4 – Casing Antenna Ports

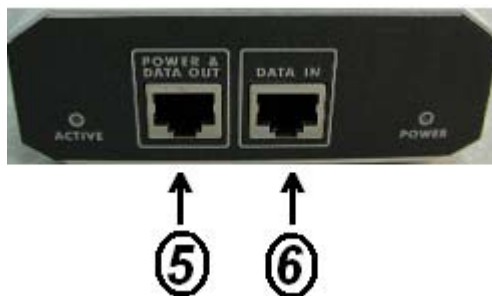

Figure 5 – ZyAIR Inline power injector

3.2 Outdoor Access Point & Bridge Bottom Panel Connections



Figure 6 - Special Ethernet Cable Connections

Table 1 - Side Panel and Connections

LABEL	DESCRIPTION AND FUNCTION
Outdoor Ethernet Connector Port	Use the included 30M MIL-C-5015 style Ethernet cable to connect the ZyAIR to the inline power injector. These ports are auto-negotiating and auto-crossover (automatically adjusts to the type of Ethernet cable you use (straight-through or crossover)).
Console Port	Use the included MIL-C-5015 style RS232 console port cable to connect the ZyAIR to the console port on your computer for initial ZyAIR configuration.

3.3 The Inline Power Injector Back Panel



Figure 7 - Inline Power Injector Back Panel

Table 2 - The Inline Power Injector Back Panel

LABEL	DESCRIPTION AND FUNCTION
AC IN 100 ~ 240V	Connect the end of the included power cord to this power socket.
After you've made the connection, connect the power cable to a power supply and look at the front panel POWER LED .	

The **POWER LED** turns steady on when the power cord is connected.

3.4 The Inline Power Injector Front Panel

Table 3 - The Inline Power Injector Front Panel

LABEL	DESCRIPTION AND FUNCTION
POWER & DATA OUT	Connect the RJ-45 Ethernet connector end of the MIL-C-5015 style Ethernet cable to this port.
DATA IN	Use an Ethernet cable to connect this port to a Local Area Network (LAN). This port is auto negotiating (can connect at 10 or 100Mbps) and auto-crossover (automatically adjusts to straight-through or crossover).

The **ACTIVE LED** turns steady on when the ZyAIR is connected to this port.



Figure 8 - Inline Power Injector Front Panel

3.5 Making the Connections

Before installing your Outdoor Access Point & Bridge system in a hard-to-reach location, we recommend that you configure and test all the devices first.

Follow the quick steps below for installation of the Outdoor Access Point & Bridge:

3.5.1 Procedure for Making the Connections

Step 1. With the unit turned off, attach the dipole antenna to the antenna connector as shown in *Figure 9*.

Do not over-tighten the antennas. Position the antenna vertically for the best omni-directional signal reception.

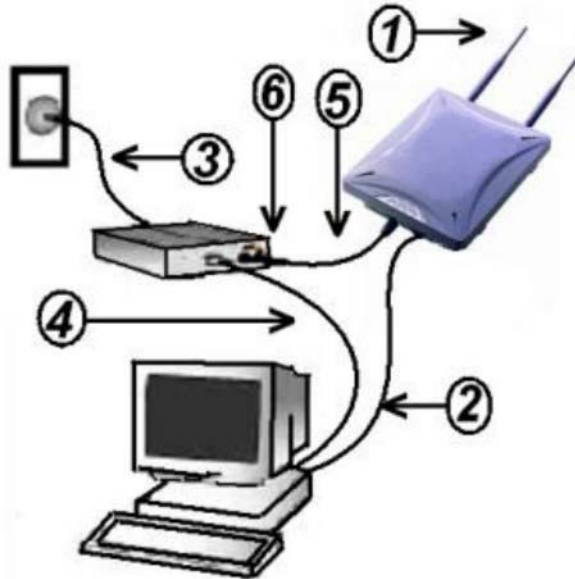

Figure 9 - Installation Layout

- Step 2.** Attach the MIL-C-5015 style (RS-232) console cable to the serial port adapter. Connect the other cable end (DB9 female) to a terminal or a PC running a terminal emulation program.
- Step 3.** Connect the female end of the power cord to the inline power injector, and then connect the male end of the power cord into a power outlet or power strip. The **POWER** LED on the front of the Inline power injector should turn on.
- Step 4.** Run the Ethernet cable (included in your package) from **DATA IN** port (on the front panel of the inline power injector) to the Ethernet port on a computer.
- Step 5.** Connect the MIL-C-5015 style Ethernet connector to the special Ethernet port on the bottom of the ZyAIR.
- Step 6.** Connect the RJ-45 Ethernet connector (the other end of the special Ethernet cable) into the **POWER & DATA OUT** port on the front of the inline power injector.

When the ZyAIR receives power over the Ethernet cable, the ZyAIR will start its boot sequence and the **ACTIVE** LED on the front of the Inline power injector will turn on.

You can configure the ZyAIR using the HTML browser, such as Internet Explorer or Netscape Navigator from a remote host or PC. See *Part I* of your ZyAIR *User's Guide* for a quick setup guide.

4 Hardware Installation

In general, the best location for the access point is at the center of your intended wireless coverage area. It is recommended that you do the initial configuration of the ZyAIR prior to mounting.

The Outdoor Access Point & Bridge device can be mounted on the side of a building or mounted to an antenna mast as described:

A wall (side) mount allows for mounting an antenna (mast) on the side of a building or on the side of an elevated penthouse. This will provide a convenient mounting location when the roof overhang is not excessive and/or the location is high enough to provide a clear line of sight.

An antenna couples RF signals onto air. A transmitter within a wireless device sends an RF signal to the antenna, which propagates the signal through the air. The antenna also operates in reverse by capturing RF signals from the air.

Choosing the right antennas and positioning them properly increases the range and coverage area of a wireless LAN.

In most situations mounting an antenna directly to the wall will not allow you to properly align the antenna with the corresponding antenna at the opposite end of your wireless link. As poor alignment will typically result in poor performance, we advise you to always mount the Outdoor Access Point & Bridge to a mast.

4.1 Antenna Mast/Antenna Requirements

To accommodate the ZyAIR, the mast must satisfy the following requirements:

- The construction of the mast must be of a sturdy, weatherproof and non-corrosive material, for example, galvanized or stainless steel construction pipe.
- Typical diameter of the mast should be between 35 mm (1.4”) and 41 mm (1.625”). Subject to the type of mast that you intend to install, other diameters are possible.
- The height of the antenna mast must be sufficient to allow the antenna to be installed at least 1.5 m (5’) above the peak of the roof. If the roof is metal, then the height of the antenna should be a minimum of 3m (10’) above the roof.
- The mast or wall-bracket must be free from any substance that may prevent a good electrical connection with the antenna, for example, paint.

4.2 Grounding

A safe grounding system is necessary to protect your outdoor installation from lightning strikes and the build-up of static electricity.

Direct grounding of the antenna mast, Outdoor Access Point & Bridge and Surge Arrester are very important. The ZyAIR has a built in Surge Arrester. The ZyAIR should be connected to the same grounding system as the antenna mast and the AC wall outlet.

The grounding system must comply with the National Electrical Code and safety standards that apply in your country. Always check with a qualified electrician if you are in doubt as to whether your outdoor installation is properly grounded.

4.3 What is Lightning Protection?

All outdoor electronic equipment is susceptible to lightning damage. Proper grounding to national and local codes is instrumental in providing human safety. Lightning Protection is used when a customer wants to maximize the reliability of the electronic system by diverting the excess energy that can be induced on any transmission lines (data, power) through a series of surge protection devices. The energy is dissipated through heat and is also diverted to the ground.

4.4 Why is Additional Protection Recommended?

Lightning, even with the built-in protection, can still damage ZyAIR equipment. This can occur for any number of reasons, such as an improperly grounded installation or if the amount of transient energy from nearby lightning exceeds what the devices can handle.

If the ZyAIR unit fails due to damage from lightning, the link is out-of-service until the unit is replaced or repaired. An external, reverting protection device can provide a higher level of protection, and greater probability of surviving lightning strikes without damage to the ZyAIR equipment.

4.5 Unpacking the ZyAIR

The ZyAIR's shipping box should be left intact and sheltered until arrival at the installation site. If the shipping container shows signs of damage, immediately notify the transportation company. Upon receipt, inspect contents to make sure that there are no missing or damaged parts (see *Packaging Specifications* in the *appendix* of the *ZyAIR User's Guide*).

Retain all the packing materials (including all internal boxes). In the unlikely event that the equipment must be returned, use the original packing materials for return shipment. The packing materials are also recommended for transporting the equipment from location to location.

4.6 Mounting the ZyAIR

Make sure the screws are securely fixed to the wall or mast and strong enough to hold the weight of the ZyAIR with the connection cables.

4.6.1 ZyAIR Mast Mounting

You can mount the outdoor component of your ZyAIR directly to a pole with an outside diameter of 37.5mm ~ 62.5mm (1.5" ~ 2.5").

To assemble the ZyAIR mast mounting components:

- Step 1.** Insert the U-bolt into the mast-mounting bracket and attach the two nuts with one lock washer and one split-lock washer.



Figure 10 - U-Bolt and Mast Mounting Bracket

- Step 2.** Insert the two screws into the sides of the first mast-mounting bracket to fix the ZyAIR to the mast-mounting bracket.



Figure 11 - Mounted ZyAIR, Back Panel

4.6.2 ZyAIR Wall Mounting

To assemble the ZyAIR wall mounting components:

- Step 1.** Place the ZyAIR face down on a flat surface.
- Step 2.** Attach the wall mounting bracket to the back of the ZyAIR using the four screws, four lock washers and four split-lock washers.



Figure 12 - Wall Mounting Brackets

- Step 3.** Refer to the following figure and mount the ZyAIR on the wall.

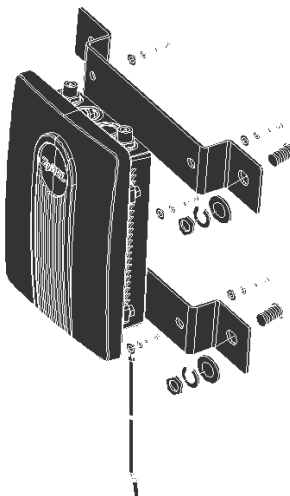

Figure 13 - Mounted ZyAIR

4.7 Power Connections

- Step 1.** Connect the power cord to the inline power injector, and then connect the male end of the power cord into a power outlet or power strip. The **POWER** LED on the front of the inline power injector should turn on.



Figure 14 – Inline Power Injector, Power Outlet

- Step 2.** Run the Ethernet cable from the **DATA IN** port (on the front of the inline power injector) to the Ethernet port on a computer.



Figure 15 - Ethernet Cable With Inline power injector

This connection is required for setting up initial configuration information. After configuration is completed, this cable will be removed, and then you should run an Ethernet cable from the Data In port (on the front of the Inline power injector) to the LAN connection (such as to a hub, bridge or directly into a patch panel).

- Step 3.** Connect the MIL-C-5015 style Ethernet connector into the special Ethernet port on the bottom of the ZyAIR.



Figure 16 - MIL-C-5015 Style Ethernet Connector

- Step 4.** Connect the RJ-45 Ethernet connector (the other end of the special Ethernet cable) into the **POWER & DATA OUT** port on the front of the inline power injector.



Figure 17 - Power & Data Out Port

- Step 5.** Connect the antennas or RF cables to the ZyAIR's two antenna ports.

4.8 Attaching Antennas

Follow the steps below to connect the supplied 5dBi Omni-direction rubber antennas.

- Step 1.** Locate the antenna connectors on the top of your ZyAIR.
- Step 2.** Screw the antennas clockwise onto the antenna connectors. The antennas should be perpendicular to the ground and parallel to each other.



Figure 18 - Antenna Attached

4.8.1 Antenna Alignment

For optimal performance of your wireless link, make sure that the antennas are properly aligned (facing one another “eye-to-eye”). To align the antennas:

- Use a pair of binoculars and/or a map of the area and compass to point the antennas to one another.
- Optimize antenna alignment if required, by making small modifications in the antenna orientation.
- Alternatively, consult a professional antenna installation service to optimize the antenna alignment.

Omni-directional antennas are characterized by a wide radiation pattern. Therefore alignment of this type of antennas is less critical than for directional antennas.

For omni-directional antennas mounted on a table, desk, and so on, point the antenna up. For omni-directional antennas mounted on a wall or ceiling, point the antenna down. For a single AP application, place omni-directional antennas as close to the center of the coverage area as possible.

For directional antennas, point the antenna in the direction of the desired coverage area.

4.8.2 Connector Type

The ZyAIR is equipped with a Reverse Polarity-N type jack, so it will work with any 2.4GHz wireless antenna with a Reverse Polarity-N type connection.

Make sure the antennas are securely screwed onto the antenna connector

The outdoor Router/Bridge antenna cabling systems can be identified by Reverse Polarity-N connectors (pictured in following)

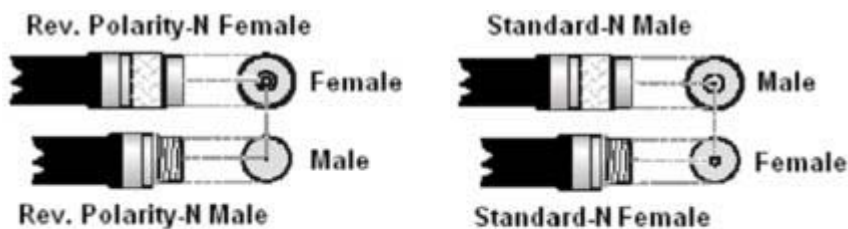

**Please Note: The gender of the connectors is NOT determined by the connector's thread, but its center pin;
A solid center pin = Male, a hollow pin = Female.**

Figure 19 – Antenna Connectors

For more information on antennae, see the *User's Guide appendix*.

5 Troubleshooting

Table 4 Troubleshooting

PROBLEM	CORRECTIVE ACTION
The POWER and/or ACTIVE LED are off on the inline power injector.	Make sure the power cord is connected into an adequate power supply and that the power supply is turned on. Disconnect and Connect the ZyAIR to the power supply. If the error persists, you may have a hardware problem. In this case, you should contact your vendor.
The ACTIVE LED on the inline power injector is off.	Check the cable connection to the ZyAIR special Ethernet port. Make sure your computer's network card is working properly.
I cannot ping any computer on the LAN.	If all of the inline power injector LEDs are off, check the cables between the ZyAIR and your computer or hub.
I cannot access the Internet.	Make sure the ZyAIR is connected to the network. Make sure you entered your username correctly. A username may be case-sensitive.