

ZyXEL

TOTAL INTERNET ACCESS SOLUTION

Prestige 100WH

Internet Access Router

User's Manual

Prestige 100WH

Internet Access Router

Copyright

Copyright © 1998 by ZyXEL Communications Corporation.

The contents of this publication may not be reproduced in any part or as a whole, transcribed, stored in a retrieval system, translated into any language, or transmitted in any form or by any means, electronic, mechanical, magnetic, optical, chemical, photocopying, manual, or otherwise, without the prior written permission of ZyXEL Communications Corporation.

Published by ZyXEL Communications Corporation. All rights reserved.

Disclaimer

ZyXEL does not assume any liability arising out of the application or use of any products, or software described herein. Neither does it convey any license under its patent rights nor the patents rights of others. ZyXEL further reserves the right to make changes in any products described herein without notice. This publication is subject to change without notice.

Trademarks

Trademarks mentioned in this publication are used for identification purposes only and may be properties of their respective owners.

Federal Communications Commission (FCC) Interference Statement

This device complies with Part 15 of FCC rules. Operation is subject to the following two conditions:

- This device may not cause harmful interference.
- This device must accept any interference received, including interference that may cause undesired operations.

This equipment has been tested and found to comply with the limits for a CLASS B digital device pursuant to Part 15 of the FCC Rules. These limits are designed to provide reasonable protection against harmful interference in a commercial environment. This equipment generates, uses, and can radiate radio frequency energy, and if not installed and used in accordance with the instructions, may cause harmful interference to radio communications.

If this equipment does cause harmful interference to radio/television reception, which can be determined by turning the equipment off and on, the user is encouraged to try to correct the interference by one or more of the following measures:

1. Reorient or relocate the receiving antenna.
2. Increase the separation between the equipment and the receiver.
3. Connect the equipment into an outlet on a circuit different from that to which the receiver is connected.
4. Consult the dealer or an experienced radio/TV technician for help.

Notice 1

Changes or modifications not expressly approved by the party responsible for compliance could void the user's authority to operate the equipment.

Notice 2

Shielded RS-232 cables are required to be used to ensure compliance with FCC Part 15, and it is the responsibility of the user to provide and use shielded RS-232 cables.

Information for Canadian Users

The Industry Canada label identifies certified equipment. This certification means that the equipment meets certain telecommunications network protective, operation, and safety requirements. The Industry Canada does not guarantee that the equipment will operate to a user's satisfaction.

Before installing this equipment, users should ensure that it is permissible to be connected to the facilities of the local telecommunications company. The equipment must also be installed using an acceptable method of connection. In some cases, the company's inside wiring associated with a single line individual service may be extended by means of a certified connector assembly. The customer should be aware that the compliance with the above conditions may not prevent degradation of service in some situations.

Repairs to certified equipment should be made by an authorized Canadian maintenance facility designated by the supplier. Any repairs or alterations made by the user to this equipment, or equipment malfunctions, may give the telecommunications company cause to request the user to disconnect the equipment.

For their own protection, users should ensure that the electrical ground connections of the power utility, telephone lines, and internal metallic water pipe system, if present, are connected together. This precaution may be particularly important in rural areas.

Caution

Users should not attempt to make such connections themselves, but should contact the appropriate electrical inspection authority, or electrician, as appropriate.

Note

This digital apparatus does not exceed the class A limits for radio noise emissions from digital apparatus set out in the radio interference regulations of Industry Canada.

ZyXEL Limited Warranty

ZyXEL warrants to the original end user (purchaser) that this product is free from any defects in materials or workmanship for a period of up to two (2) years from the date of purchase. During the warranty period, and upon proof of purchase, should the product have indications of failure due to faulty workmanship and/or materials, ZyXEL will, at its discretion, repair or replace the defective products or components without charge for either parts or labor, and to whatever extent it shall deem necessary to restore the product or components to proper operating condition. Any replacement will consist of a new or re-manufactured functionally equivalent product of equal value, and will be solely at the discretion of ZyXEL. This warranty shall not apply if the product is modified, misused, tampered with, damaged by an act of God, or subjected to abnormal working conditions.

Note

Repair or replacement, as provided under this warranty, is the exclusive remedy of the purchaser. This warranty is in lieu of all other warranties, express or implied, including any implied warranty of merchantability or fitness for a particular use or purpose. ZyXEL shall in no event be held liable for indirect or consequential damages of any kind of character to the purchaser.

To obtain the services of this warranty, contact ZyXEL's Service Center; refer to the separate Warranty Card for your Return Material Authorization number (RMA). Products must be returned Postage Prepaid. It is recommended that the unit be insured when shipped. Any returned products without proof of purchase or those with an out-dated warranty will be repaired or replaced (at the discretion of ZyXEL) and the customer will be billed for parts and labor. All repaired or replaced products will be shipped by ZyXEL to the corresponding return address, Postage Paid (USA and territories only). If the customer desires some other return destination beyond the U.S. borders, the customer shall bear the cost of the return shipment. This warranty gives you specific legal rights, and you may also have other rights which vary from state to state.

Customer Support

If you have questions about your ZyXEL product or desire assistance, contact ZyXEL Communications Corporation offices worldwide, in one of the following ways:

North America

ZyXEL Communications Inc.

4920 E. La Palma Avenue
Anaheim, CA 92807

USA

Telephone: (714) 693-0808 (call between 8:00 AM and 5:00 PM PST)

Facsimile: (714) 693-8811

E-mail: - Sales Inquiries: sales@zyxel.com

- Technical Support: support@zyxel.com

Worldwide Support

ZyXEL Communications Corporation

6, Innovation Road II, Science-Based Industrial Park
Hsinchu, Taiwan 300, R.O.C.

Telephone: 886-3-578-3942 Ext.: 266 (call between 8:00 AM and 5:00 PM [Taiwan time GMT+8:00])

Facsimile: 886-3-578-2439

E-mail: - Sales Inquiries: sales@zyxel.com.tw

- Technical Support: support@zyxel.com.tw

Product Information

For product information, visit our site on the **World Wide Web**: <http://www.zyxel.com>.

FTP Information

Information such as ZyXEL software and ROM updates is available for download at these FTP addresses:

North America: [ftp.zyxel.com](ftp://ftp.zyxel.com)

Europe: [ftp.zyxel.co.at](ftp://ftp.zyxel.co.at)

Table of Contents

Table of Contents	vii
List of Figures	xi
List of Tables	xiii
Preface	xv
Chapter 1	
Getting to Know Your Internet Access Router	1-1
1.1 Prestige 100WH Internet Access Router	1-1
1.2 Features of Prestige 100WH.....	1-1
1.3 The WAN Port	1-3
1.3.1 <i>Terminology</i>	1-3
1.4 Prestige 100WH Front Panel	1-34
1.4.1 <i>Front Panel Description</i>	1-74
1.4.2 <i>Front Panel LEDs</i>	1-75
1.4.3 <i>WAN Port Status LEDs</i>	1-86
1.5 Prestige 100WH Back Panel.....	1-36
1.6 Applications for Prestige 100WH.....	1-5
1.6.1 <i>Internet Access</i>	1-7
1.6.2 <i>Internet Single User Account</i>	1-7
1.6.3 <i>LAN-to-LAN Connection</i>	1-8
1.6.4 <i>Remote Access Server</i>	1-9
Chapter 2	
Hardware Installation & Initial Setup	2-1
2.1 Unpacking your Internet Access Router	2-1
2.2 Additional Installation Requirements	2-2
2.3 Connect your Internet Access Router.....	2-3
2.3.1 <i>Prestige 100WH Connections</i>	2-3
2.4 Connecting External Hubs	2-5

2.5	Power On Your <i>Prestige</i>	2-5
2.6	Navigating the SMT Interface.....	2-7
2.6.1	<i>System Management Terminal Interface Summary</i>	2-8
2.7	Changing the System Password	2-8
2.8	General Setup	2-10
2.9	Prestige 100WH WAN Port Setup.....	2-12
2.9.1	<i>WAN Port Setup</i>	2-12
2.9.2	<i>Advanced WAN Port Setup</i>	2-14

Chapter 3

Internet Access Application.....	3-1	
3.1	Ethernet Setup	3-1
3.2	TCP/IP Ethernet and DHCP Setup.....	3-2
3.2.1	<i>IP Address and Subnet Mask</i>	3-2
3.2.2	<i>RIP Setup</i>	3-3
3.2.3	<i>DHCP Configuration</i>	3-3
3.2.4	<i>More on IP Address and Subnet Mask</i>	3-4
3.3	Configuring TCP/IP and DHCP	3-5
3.4	Internet Access Configuration	3-7
3.5	Single User Account	3-9
3.5.1	<i>Advantages of SUA</i>	3-10
3.5.2	<i>Configuration for Single User Account</i>	3-11
3.6	Configuring Backup ISP Accounts.....	3-12
3.6.1	<i>Configure a Backup ISP</i>	3-13
3.6.2	<i>To Switch ISP</i>	3-13
3.7	Editing Script Options	3-14

Chapter 4

Remote Node Configuration.....	4-1	
4.1	Remote Node Setup	4-1
4.1.1	<i>Remote Node Profile</i>	4-1
4.1.2	<i>Editing PPP Options</i>	4-7
4.2	Outgoing Authentication Protocol.....	4-8

Chapter 5	
Remote Node TCP/IP Configuration	5-1
5.1 LAN-to-LAN Application	5-1
5.1.1 Remote Node Setup	5-2
5.1.2 Static Route Setup	5-6
Chapter 6	
Dial-in Server Applications.....	6-1
6.1 Telecommuting	6-1
6.2 LAN-to-LAN Application	6-3
6.3 Default Dial-In Setup.....	6-4
6.4 Dial-In Users Setup.....	6-8
6.5 CLID Authentication.....	6-10
6.6 Callback	6-10
Chapter 7	
Filter Configuration.....	7-1
7.1 Configuring a Filter Set	7-3
7.1.1 Filter Rules Summary Menu	7-4
7.2 Configuring a Filter Rule	7-6
7.2.1 TCP/IP Filter Rule	7-7
7.2.2 Generic Filter Rule	7-10
Chapter 8	
System Password.....	8-1
8.1 Configure the System Password	8-1
Chapter 9	
Telnet Configuration and Capabilities	9-1
9.1 About Telnet Configuration.....	9-1
9.2 Single Administrator.....	9-2
9.2.1 System Timeout	9-2

Chapter 10

System Maintenance	10-1
10.1 System Status	10-2
10.2 Terminal Baud Rate	10-5
10.3 Log and Trace	10-5
10.3.1 View Error Log	10-6
10.3.2 Syslog And Accounting	10-7
10.4 Diagnostic	10-9
10.5 Backup Configuration	10-12
10.6 Restore Configuration	10-12
10.7 Firmware Update	10-13
10.7.1 Uploading Firmware	10-14
10.7.2 Uploading ROM File	10-15
10.8 Command Interpreter Mode	10-16
10.9 Call Control	10-16
10.9.1 Blacklist	10-17
10.9.2 Budget Management	10-18

Chapter 11

Troubleshooting	11-1
11.1 Problems Starting Up the <i>Prestige</i>	11-1
11.2 Problems With the Modem	11-2
11.3 Problems with the LAN Interface	11-2
11.4 Problems Connecting to a Remote node or ISP	11-3
11.5 Problems with Remote User Dial-in	11-3
Index	I-1

List of Figures

Figure 1-1.	<i>Prestige 100WH</i> Front Panel.....	1-84
Figure 1-2.	<i>Prestige 100WH</i> Back Panel.....	1-86
Figure 1-3.	Internet Access Application.....	1-7
Figure 1-4.	LAN-to-LAN Connection Application.....	1-8
Figure 1-5.	Telecommuting/Remote Access Application.....	1-9
Figure 2-1.	Connect <i>Prestige 100WH</i>	2-3
Figure 2-2.	Power-On Display.....	2-5
Figure 2-3.	Login Screen.....	2-6
Figure 2-4.	SMT Main Menu.....	2-8
Figure 2-5.	Menu 23.1 - System Password.....	2-9
Figure 2-6.	Menu 1 - General Setup.....	2-10
Figure 2-7.	Menu 2.1 – WAN Port Setup.....	2-12
Figure 2-8.	Menu 2.1.1 - Advanced WAN Setup.....	2-14
Figure 3-1.	Menu 3 - Ethernet Setup.....	3-1
Figure 3-2.	Menu 3.1 - General Ethernet Setup.....	3-2
Figure 3-3.	Menu 3.2 - TCP/IP and DHCP Ethernet Setup.....	3-5
Figure 3-4.	Menu 4 - Internet Access Setup.....	3-7
Figure 3-5.	Single User Account Topology.....	3-9
Figure 3-6.	Menu 4 - Internet Access Setup for Single User Account.....	3-11
Figure 3-7.	Menu 4.1 - Remote Node Script.....	3-15
Figure 4-1.	Menu 11 - Remote Node Setup.....	4-1
Figure 4-2.	Menu 11.1 - Remote Node Profile for Dial-up Line Applications.....	4-2
Figure 4-3.	Menu 11.2 - Remote Node PPP Options.....	4-7
Figure 5-1.	LAN-to-LAN Application with TCP/IP.....	5-1
Figure 5-2.	Menu 11.3- Remote Node Network Layer Options for TCP/IP Applications.....	5-2
Figure 5-3.	Sample IP Addresses for a LAN-to-LAN Connection with TCP/IP.....	5-3
Figure 5-4.	Example of Static Routing Topology.....	5-6

Figure 5-5.	Menu 12 - Static Route Setup	5-7
Figure 5-6.	Menu 12.1 - Edit IP Static Route	5-7
Figure 6-1.	Example of Remote User: Telecommuter	6-2
Figure 6-2.	Example of a LAN-to-LAN Application	6-3
Figure 6-3.	Menu 13 - Default Dial-in Setup	6-4
Figure 6-4.	Menu 14 - Dial-in User Setup	6-8
Figure 6-5.	Menu 14.1 - Edit Dial-in User	6-8
Figure 7-1.	Outgoing Packet Filtering Process	7-2
Figure 7-2.	Menu 21 - Filter Set Configuration.....	7-3
Figure 7-3.	Menu 21.1 - Filter Rules Summary	7-4
Figure 7-4.	Menu 21.1.1 - TCP/IP Filter Rule	7-7
Figure 7-5.	Menu 21.1.2 - Generic Filter Rule	7-10
Figure 9-1.	Telnet Configuration on a TCP/IP Network	9-1
Figure 10-1.	Menu 24 - System Maintenance.....	10-1
Figure 10-2.	Menu 24.1 - System Maintenance - Status	10-2
Figure 10-3.	LAN Packet Which Triggered Last Call.....	10-4
Figure 10-4.	Menu 24.2 - System Maintenance - Change Terminal Baud Rate	10-5
Figure 10-5.	Examples of Error and Information Messages	10-6
Figure 10-6.	Menu 24.3.2 - System Maintenance - Syslog and Accounting.....	10-7
Figure 10-7.	Menu 24.4 - System Maintenance - Diagnostic.....	10-9
Figure 10-8.	Trace Display for a Successful IPCP Connection Via Manual Call	10-11
Figure 10-9.	Trace Display of a Failed Authentication.....	10-11
Figure 10-10.	Menu 24.7 - System Maintenance - Upload Firmware	10-13
Figure 10-11.	Menu 24.7.1 - Example of Uploading RAS Using PCPLUS.....	10-14
Figure 10-12.	Menu 24.7.2 - System Maintenance - Upload ROM File	10-15
Figure 10-15.	Menu 24.9 - System Maintenance - Call Control.....	10-16
Figure 10-16.	Menu 24.9.2 - Blacklist.....	10-17
Figure 10-17.	Menu 24.9.3 - Budget Management	10-18

List of Tables

Table 1-1.	LED Functions.....	1-5
Table 2-1.	Item Checklist	2-1
Table 2-2.	Main Menu Commands	2-7
Table 2-3.	Main Menu Summary	2-8
Table 2-4.	General Setup Menu Fields.....	2-11
Table 2-5.	WAN Port Setup Menu Fields	2-13
Table 2-6.	Advanced WAN Setup Fields.....	2-15
Table 2-7.	Advanced Modem Setup Call Control Parameters	2-16
Table 3-1.	DHCP Ethernet Setup Menu Fields	3-6
Table 3-2.	TCP/IP Ethernet Setup Menu Fields	3-6
Table 3-3.	Internet Account Information.....	3-7
Table 3-4.	Internet Access Setup Menu Fields	3-8
Table 3-5.	Single User Account Menu Fields.....	3-12
Table 3-6.	Internet Setup Script Menu Fields.....	3-15
Table 4-1.	Remote Node Profile Menu Fields for Dial-up Line Applications	4-2
Table 4-2.	Remote Node PPP Options Menu Fields	4-7
Table 5-1.	Remote Node Network Layer Options for a TCP/IP Configuration	5-4
Table 5-2.	Edit IP Static Route Menu Fields	5-8
Table 6-1.	Remote Dial-in Users/Remote Nodes Comparison Chart.....	6-1
Table 6-2.	Default Dial-in Setup Fields	6-5
Table 6-3.	Edit Dial-in User Menu Fields	6-9
Table 7-1.	Abbreviations Used in the Filter Rules Summary Menu.....	7-4
Table 7-2.	Abbreviations Used If Filter Type Is IP	7-5
Table 7-3.	Abbreviations Used If Filter Type Is GEN	7-6
Table 7-4.	TCP/IP Filter Rule Menu Fields	7-8
Table 7-5.	Generic Filter Rule Menu Fields.....	7-11

Table 10-1.	System Maintenance - Status Menu Fields	10-3
Table 10-2.	System Maintenance Menu Syslog Parameters.....	10-7
Table 10-3.	System Maintenance Menu Diagnostic Test Options.....	10-10
Table 11-1.	Troubleshooting the Start-Up of your <i>Prestige</i>	11-1
Table 11-2.	Troubleshooting a WAN Port Connection.....	11-2
Table 11-3.	Troubleshooting the LAN Interface	11-2
Table 11-4.	Troubleshooting a Connection to a Remote Node or ISP	11-3
Table 11-5.	Troubleshooting Remote User Dial-in	11-3

Preface

About Your Internet Access Router

Congratulations on your purchase of the *Prestige 100WH* Internet Access Router.

The *Prestige 100WH* is a high-performance Router/Hub that offers a complete solution for your WAN (Wide Area Network) applications such as Internet access, LAN-to-LAN connections, telecommuting and remote access over a regular telephone line (or PSTN, Public Switched Telephone Network) or ISDN (Integrated Service Digital Network). In addition, the integrated Ethernet 10Base-T hub saves you the cost and clutter of an external hub.

Your *Prestige 100WH* is easy to install and to configure since you do not need to set any switch. All functions of the *Prestige* are software configurable via either the SMT (System Management Terminal) Interface or the Java-based *Prestige Web Configurator* (PWC). This manual concentrates on configuration via the SMT; for detailed information on PWC, please refer to the *Prestige Web Configuration User's Manual*.

About This User's Manual

This user's manual covers all aspects of your *Prestige 100WH* operations and shows you how to get the best out of the multiple advanced features of your Internet Access Router.

This manual consists of eleven chapters designed to guide you through the correct configuration of your *Prestige 100WH* for various applications.

Structure of this Manual

This manual is divided into five parts:

1. *Getting Started* (Chapters 1-2), is structured as a step-by-step guide to help you connect, install and setup your *Prestige 100WH* to operate on your network.
2. *The Internet* (Chapter 3), describes how to configure your *Prestige 100WH* to connect to the Internet.
3. *Setting Up Advanced Applications* (Chapters 4-6), describes how to use your *Prestige* for more advanced applications such as Telecommuting and LAN-to-LAN.
4. *Management & Maintenance* (Chapters 7-10), provides information on access control and logging features for network administrators.
5. *Troubleshooting* (Chapter 11), provides information about solving common problems.

Regardless of your particular application, it is important that you follow the steps outlined in *Chapters 1-2* to correctly connect your *Prestige 100WH* to your LAN. You can then refer the appropriate chapters of the manual depending on which applications you wish to use.

Orientation Map

The following *Orientation Map* is designed to guide you through a quick and correct installation of your *Prestige*. According to your particular application (Internet, Telecommuting, LAN-to-LAN Connection), follow the path outlined in this *Orientation Map* to refer to the appropriate chapters in this manual. Read the instructions in each chapter carefully for a successful configuration of your *Prestige*.

Orientation Map

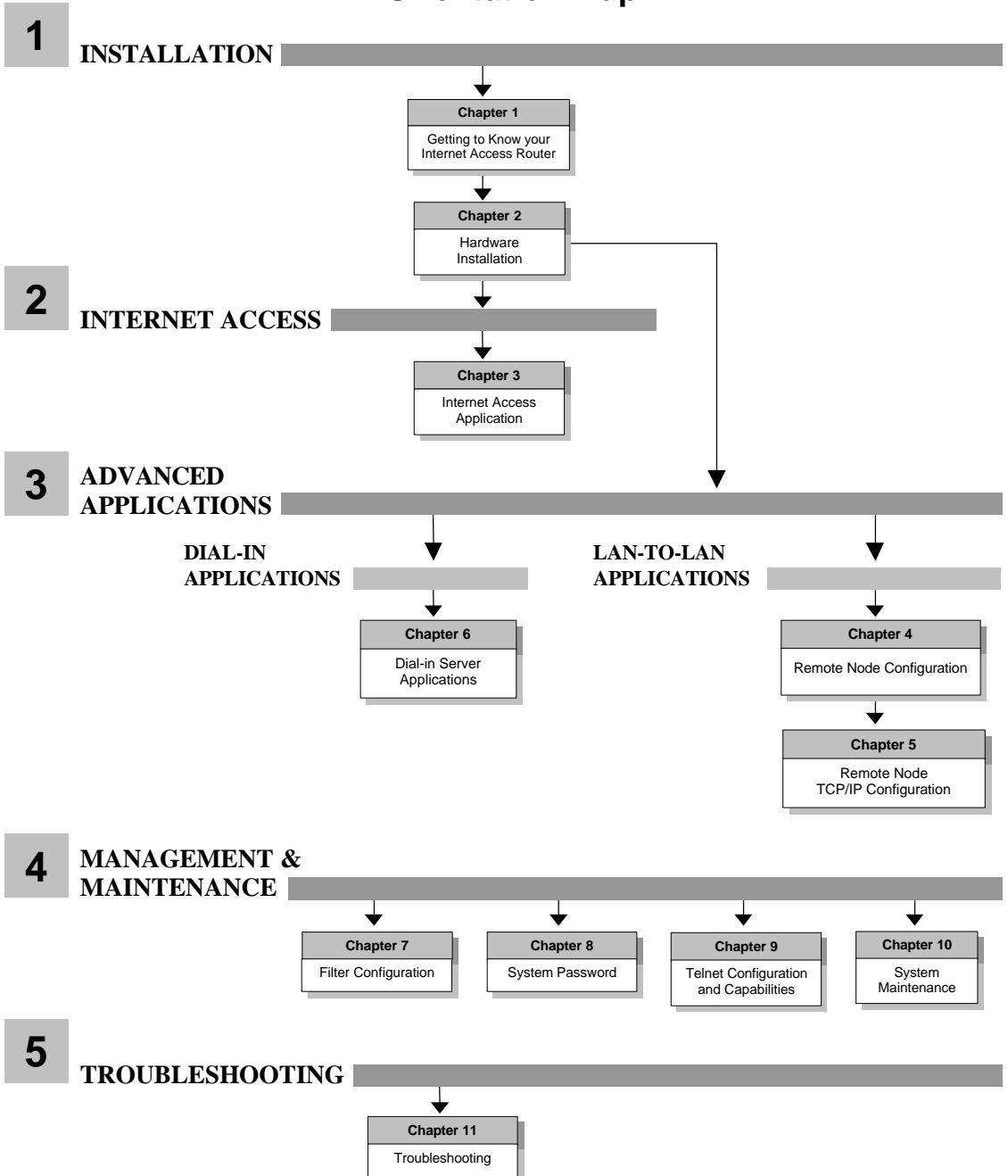

Chapter 1

Getting to Know Your Internet Access Router

This chapter describes the key features and applications of your *Prestige 100WH* Internet Access Router.

1.1 Prestige 100WH Internet Access Router

Congratulations on the purchase of your ZyXEL *Prestige 100WH* Internet Access Router. Your *Prestige* integrates a 4-port hub and one high-speed WAN (Wide Area Network) port into a single package. The *Prestige* is ideal for everything from Internet browsing to dial-in server to making LAN-to-LAN connections to remote networks.

1.2 Features of Prestige 100WH

Your *Prestige* is packed with a number of features that give it the flexibility to provide a complete networking solution for almost any user.

- **Ease of Installation**

Your *Prestige* is quick and easy to install. Physically, it resembles an external modem except for the fact that it is a router/hub.

- **High-Speed WAN Port**

The high speed RS232 WAN port allows you to use either a modem or an ISDN TA (Terminal Adapter) for your wide area networking applications.

- **Protocols Supported**

- ◆ TCP/IP (Transmission Control Protocol/Internet Protocol) network layer protocol.
- ◆ PPP (Point-to-Point Protocol) link layer protocol.
- ◆ SUA™ (Single User Account) and NAT (Network Address Translation).

- **Integrated 4-Port Ethernet Hub**

The built-in 4-port Ethernet 10base-T hub saves you the cost and the clutter of an external hub.

- **Dial-On-Demand**

The Dial-On-Demand feature allows the *Prestige* to automatically place a call whenever you use your router to access the Internet.

- **Full Network Management**

Your *Prestige* allows menu-driven network management via an RS-232/telnet connection or the Java-based PWC. Your *Prestige* is also equipped with a Call Detail Record to help analyze and manage your telephone bill.

- **PAP and CHAP Security**

The *Prestige* supports PAP (Password Authentication Protocol) and CHAP (Challenge Handshake Authentication Protocol). CHAP is more secure since the password is scrambled prior to transmission. However, PAP is readily available on more platforms.

- **DHCP Support**

DHCP (Dynamic Host Configuration Protocol) allows you to automatically assign TCP/IP settings to hosts on your network.

- **Call Control**

Your *Prestige* provides budget management for outgoing calls and maintains a blacklist for unreachable phone numbers in order to save you the expense of unnecessary charges.

- **Data Compression**

Your *Prestige* incorporates Stac data compression to speed up data transfer. Stac is the de facto standard for compression over PPP links.

- **Networking Compatibility**

Your *Prestige* is compatible with remote access products from other manufacturers such as Ascend, Cisco, and 3Com. Furthermore, it supports Microsoft Windows 95 and Windows NT remote access capability.

1.3 The WAN Port

The WAN port is a high-speed, asynchronous RS232 serial port that allows you to connect a modem or an ISDN Terminal Adapter (TA) to the *Prestige*. For brevity's sake, we will refer to a modem or a TA categorically as an "external WAN device", or simply a "WAN device" from now on.

The WAN port supports up to 460.8 kbps (kilobits per second) throughout, which is more than twice as fast as the fastest modem with V.42bis compression.

1.3.1 Terminology

- **DCE & DTE**

On the two ends of an RS-232 connection, the equipment closest to the telephone line is called the DCE (Data Communications Equipment) and the other the DTE (Data Terminal Equipment). In our case, the modem or the ISDN TA is the DCE, and the *Prestige* is the DTE.

- **PSTN & POTS**

Collectively, the voice grade network of the telephone companies is called PSTN (Public Switched Telephone Network), and a regular telephone line is often referred to as a POTS (Plain Old Telephone Service)

1.4 Prestige 100WH Front Panel

1.4.1 Front Panel Description

- ① :PWR = Power LED
- ② :RUN = Normal Operation (Blinking)
- ③ :ETHERNET (COL, 1, 2, 3, 4) = 4-PORT 10Base-T HUB (Collisions on LAN, Active Ethernet Port #)
- ④ :WAN (RDY, TXD, RXD, DTR, RTS, CTS) = WAN Port (Ready, Transmit, Receive, DTE Ready, Request to Send, Clear to Send)

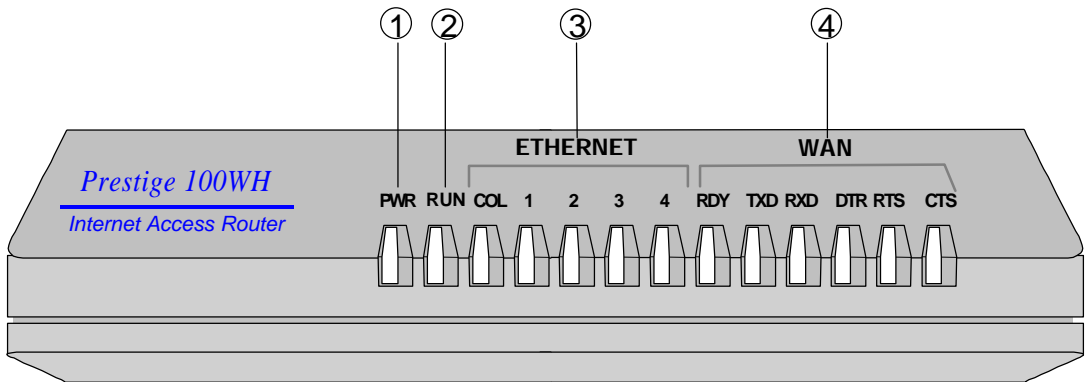

Figure 1-1. Prestige 100WH Front Panel

1.4.2 Front Panel LEDS

The LED indicator lights on the front panel indicate the operational status of your *Prestige*. The following table describes the LED functions:

Table 1-1. LED Functions

LED		Function	Indicator Status	Active	Description
PWR		Power LED	Green	On	Power is being applied to the <i>Prestige</i> .
RUN		Running Status LED	Green	Blinking	The <i>Prestige</i> is functioning properly.
ETHER -NET	COL	Collisions	Green	On	Transmission collisions have occurred on the LAN.
	1,2,3,4	Link status & Activity	Green	On	An active station is connected to the port.
				Blinking	The station connected to the port is transmitting.
WAN Port	RDY	Ready	Green	On	The WAN port is ready.
	CD	Carrier Detect	Green	On	The connection is ready for data transfer.
	TXD	Transmit	Green	Blinking	Traffic is being transmitted from the <i>Prestige</i> .
	RXD	Receive	Green	Blinking	Traffic is being received from the WAN device.
	RTS	Request to Send	Green	On	The <i>Prestige</i> is ready to receive data.
	CTS	Clear to Send	Green	On	The WAN device is ready to receive data.

1.4.3 WAN Port Status LEDs

CD (Carrier Detect) signal is sent by the WAN device to indicate that line negotiation is successful and that it is ready for data transfer.

RTS (Request to Send) and CTS (Clear to Send) are hardware flow control signals. RTS is from the DTE (the *Prestige*) while CTS is from the DCE (the WAN device).

1.5 Prestige 100WH Back Panel

The following figure helps you identify the rear panel ports of your *Prestige 100WH*. Refer to this diagram when attempting to make connections.

- ① :POWER = Input power connector to the AC adapter.
- ② :ETHERNET = 4 x RJ-45 ETHERNET 10Base-T ports.
- ③ :CONSOLE = DB-9 (female) Console port.
- ④ :WAN = DB-25 (male) WAN port.

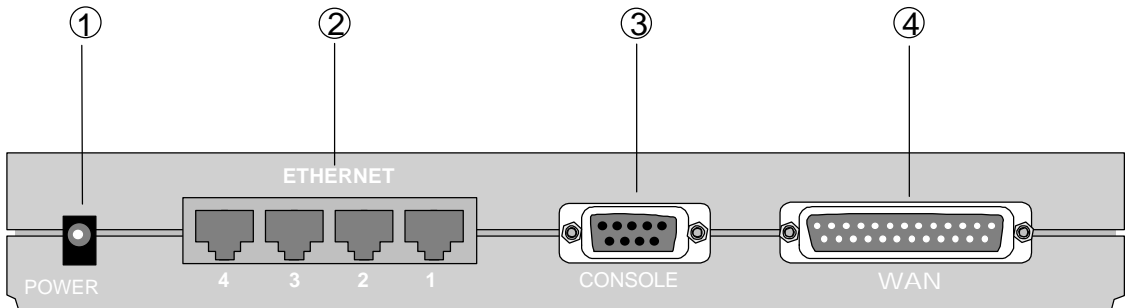

Figure 1-2. *Prestige 100WH* Back Panel

1.6 Applications for Prestige 100WH

The *Prestige* offers complete solutions for your WAN applications such as Internet Access, LAN-to-LAN Connections, telecommuting and remote access.

1.6.1 Internet Access

The *Prestige* is the ideal high-speed solution for Internet Access. Your *Prestige* supports the TCP/IP protocol, which is the *lingua franca* of the Internet. It is also compatible with access servers manufactured by major vendors such as Cisco and Ascend. A typical Internet Access application is shown in Figure 1-3.

Figure 1-3. Internet Access Application

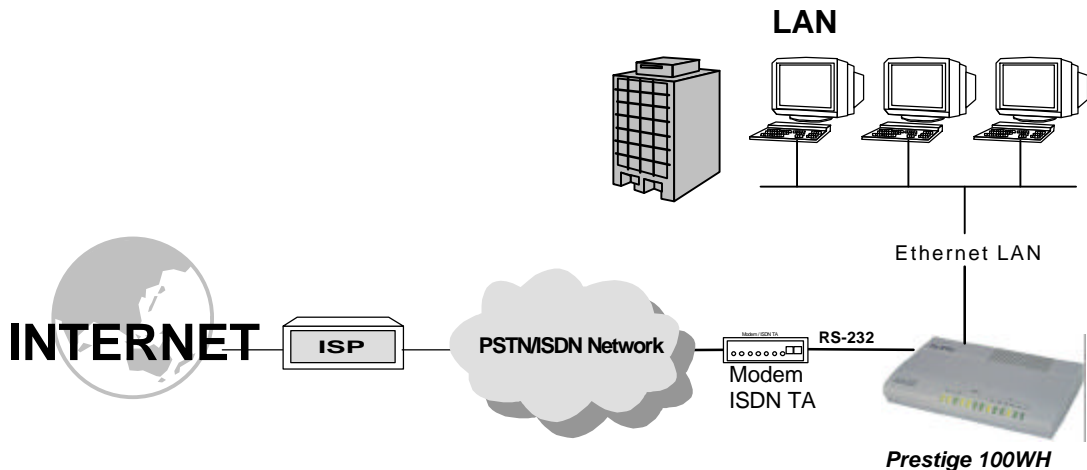

1.6.2 Internet Single User Account

For a small office environment, the Single User Account (SUA) feature allows multiple users on the LAN to access the Internet concurrently for the cost of a single user. The Single User Account address mapping can also be used for LAN to LAN connection.

1.6.3 LAN-to-LAN Connection

Your *Prestige* can dial to and answer calls from another remote access router. A typical LAN-to-LAN application for your *Prestige* is to connect the Corporate Office LAN with the Branch Office, as shown in Figure 1-4.

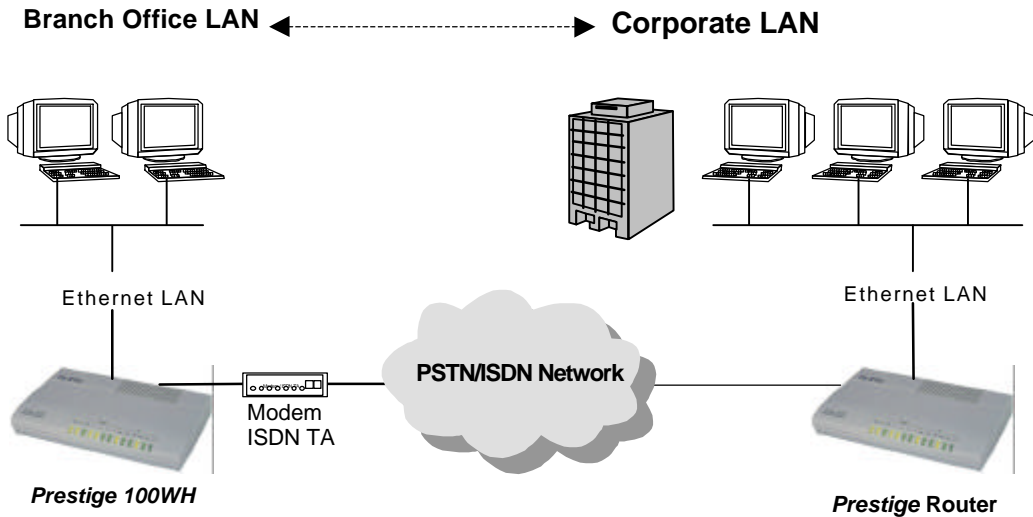

Figure 1-4. LAN-to-LAN Connection Application

1.6.4 Remote Access Server

Your *Prestige* allows remote users to dial-in and gain access to your LAN. This feature enables users that have workstations with remote access capabilities (for example, Windows 95), to dial in using a modem to access the network resources without physically being in the office. Figure 1-5 shows how a remote user can connect to its corporate office via a modem.

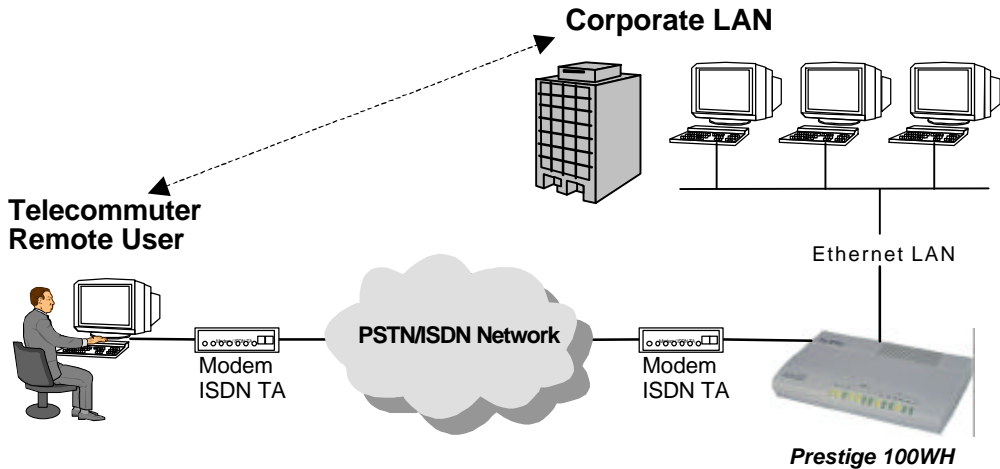

Figure 1-5. Telecommuting/Remote Access Application

Either PAP or CHAP authentication may be used to control the access from remote users to the corporate LAN. You can also use call-back for security and/or accounting purposes.

Chapter 2

Hardware Installation & Initial Setup

2.1 Unpacking your Internet Access Router

Before you proceed further, check all items you received with your *Prestige* against this list to make sure nothing is missing. The complete package should include:

Table 2-1. Item Checklist

Package Contents	Prestige 100WH
<i>Prestige 100WH</i> Internet Access Router	1
Power Adapter	1
DB-9 female/DB-9 male RS-232 Cable	1
DB-25 female/DB-9 male Console Cable Adapter	1
LAN Straight Cable (white tag)	1
Warranty Card	1
Instruction Card	1
<i>Prestige 100WH</i> Quick Start Guide	1
<i>Prestige 100WH</i> User's Manual	1
<i>Prestige Web Configurator</i> CD	1
<i>Prestige Web Configurator</i> User's Manual	1

2.2 Additional Installation Requirements

In addition to the contents of your package, there are other hardware and software requirements you need before you can install and use your *Prestige*. These requirements include:

- A computer with Ethernet 10Base-T NIC (Network Interface Card).
- A computer equipped with communications software (for example, Hyper Terminal in Win95) configured to the following parameters:
 - VT100 terminal emulation.
 - 9600 Baud rate.
 - No parity, 8 Data bits, 1 Stop bit.

After the *Prestige* has been successfully connected to your network, you can make future changes to the configuration through telnet application.

2.3 Connect your Internet Access Router

2.3.1 Prestige 100WH Connections

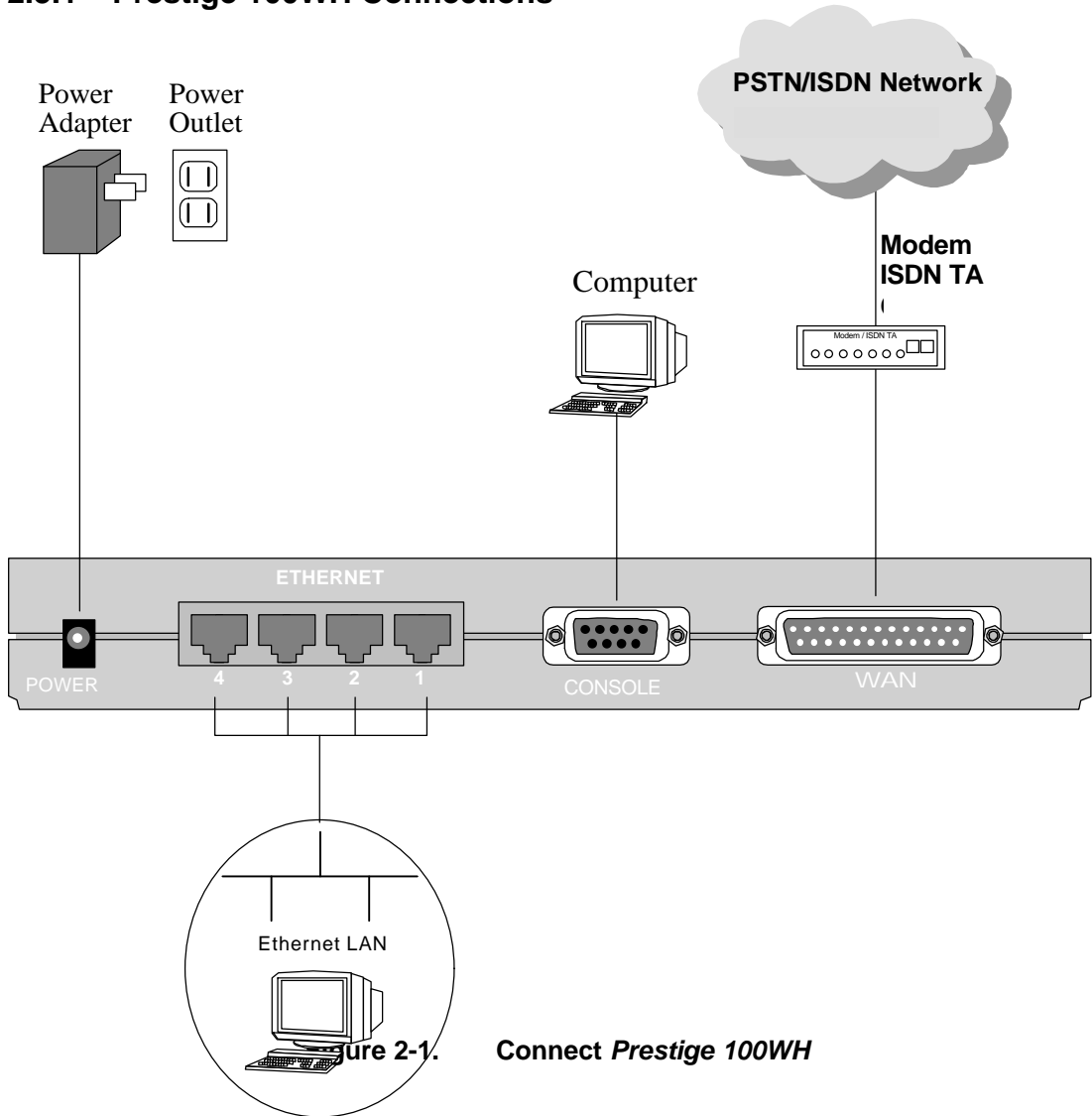

This section outlines how to connect your *Prestige* to the LAN and the telephone line. Refer to Figure 1-2 to identify all of the ports. Then see Figure 2-1 when you attempt to make the various connections.

Follow these steps for a quick and correct installation of your *Prestige*.

Step 1. Connect Your Computer and Your Prestige

For the initial setup and configuration of your *Prestige*, you must use a terminal emulator on a workstation and connect the workstation's serial (COM) port to the console port with a RS-232 cable.

After your *Prestige* has been successfully installed, you can modify the configuration through a remote telnet connection. See *Chapter 9 - Telnet Configuration and Capabilities* for detailed instructions on using telnet to configure your *Prestige*.

Step 2. Connect the WAN Device

Connect the DTE port of the WAN device to the WAN port of the Prestige with a RS-232 cable. Please follow the instructions of your WAN device to connect it to the telephone or ISDN network and to the power outlet. Power on the WAN device.

Step 3. Ethernet Connections

Use Ethernet ports 1, 2, 3 and 4 at the rear panel to create an Ethernet 10Base-T network. Connect a workstation to the *Prestige* using a straight-through 10Base-T cable, which is a Unshielded Twisted Pair (UTP) cable with RJ-45 connectors that look like a bigger telephone plug with 8 pins.

Step 4. Connect the Power Adapter to your Prestige

Plug the power adapter into the port labeled POWER on the rear panel of your *Prestige*.

2.4 Connecting External Hubs

The *Prestige* can accommodate up to 4 workstations on the built-in Ethernet hub; if you have more than 4, then you need an external hub for the additional ones. If this is the case, connect the external hub to the *Prestige* using a straight-through cable from the uplink port of the external hub to one of the 4 Ethernet ports of the *Prestige*. Please make sure that the uplink port on the external hub is in the uplink mode (usually with a toggle switch). If your external hub does not have an uplink port, then you must use a crossover cable to daisy-chain it to the *Prestige*.

2.5 Power On Your *Prestige*

At this point, you should have connected the computer, the telephone line, the Ethernet cable, and the power supply to your *Prestige*. You can now power on your *Prestige* by plugging the AC adapter to the appropriate power outlet.

Step 1. Initial Screen

When you power on your *Prestige*, the Internet Access Router performs several internal tests and performs a modem initialization. After initialization, the *Prestige* asks you to press [Enter] to continue, as shown in Figure 2-2.

Figure 2-2. Power-On Display

```
Copyright (c) 1994 - 1998 ZyXEL Communications Corp.
ethernet address: 00:a0:c5:00:10:32
Wan port init ... done
Modem init . inactive

Press ENTER to continue...
```

Enter Password

The Login screen appears prompting you to enter the password, as shown in Figure 2-3.

For your first login, enter the default password “1234” to get into the Main Menu of the System Management Terminal (SMT). As you type a password, the screen displays an (X) for each character you typed.

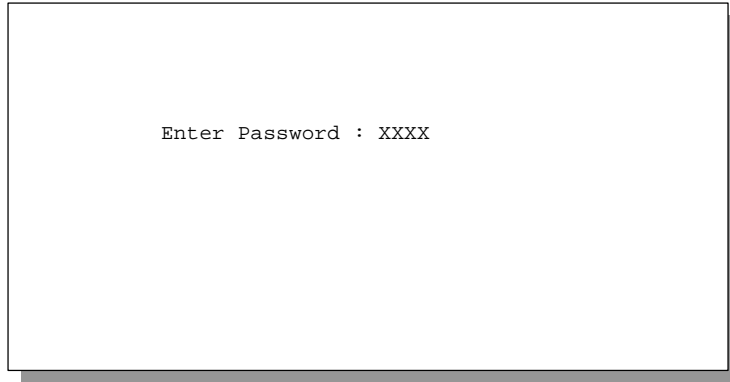

Figure 2-3. Login Screen

1. Note that the default password is “1234”.
2. Note that if there is no activity for longer than 5 minutes, your *Prestige* will automatically log you out and display a blank screen. If you see a blank screen, press [Enter] to bring up the password screen.

2.6 Navigating the SMT Interface

The SMT (System Management Terminal) is the interface that you use to configure your *Prestige*.

Several operations that you should be familiar with before you attempt to modify the configuration are listed in Table 2-2.

Table 2-2. Main Menu Commands

Operation	Press/<read>	Description
Move forward to another menu	[Enter]	To move forward to a sub-menu, type in the number of the desired sub-menu and press [Enter].
Move backward to a previous menu	[Esc]	Press the [Esc] key to move back to the previous menu.
Move the cursor	[Enter] or [Up]/[Down] arrow keys	Within a menu, press [Enter] to move to the next field. You can also use the [Up]/[Down] arrow keys to move to the previous and the next field, respectively.
Enter information	Fill in, or Press the [Space bar] to toggle	There are two types of fields that you will need to fill in. The first requires you to type in the appropriate information. The second gives you choices to choose from. In the second case, press the [Space bar] to cycle through the available choices.
Required fields	<?>	All fields with the symbol <?> must be filled in order to be able to save the new configuration.
N/A fields	<N/A>	Some of the fields in the SMT will show a <N/A>. This symbol refers to an option that is not available.
Save your configuration	[Enter]	Save your configuration by pressing [Enter] at the message: [Press ENTER to confirm or ESC to cancel]. Saving the data on the screen will take you, in most cases to the previous menu.
Exit the SMT	Type 99, then press [Enter].	Type 99 at the Main Menu prompt and press [Enter] to exit the SMT interface.

The SMT displays the Main Menu, as shown in Figure 2-4.

```

Copyright (c) 1994 - 1998 ZyXEL Communications Corp.
Prestige 100WH Main Menu

Getting Started
1. General Setup
2. Wan Setup
3. Ethernet Setup
4. Internet Access Setup

Advanced Applications
11. Remote Node Setup
12. Static Routing Setup
13. Default Dial-in Setup
14. Dial-in User Setup

Advanced Management
21. Filter Set Configuration
23. System Password
24. System Maintenance

99. Exit

Enter Menu Selection Number:
    
```

2.6.1 System Management Terminal Interface Summary

Table 2-3. Main Menu Summary

#	Menu Title	Description
1	General Setup	Access this menu to setup general information.
2	Modem Setup	Access this menu to setup modem configuration.
3	Ethernet Setup	Access this menu to setup Ethernet configuration.
4	Internet Access Setup	A quick and easy way to setup Internet connection.
11	Remote Node Setup	Access this menu to setup the remote nodes, including Internet connection. <i>Prestige</i> supports up to four remote nodes.
12	Static Routing Setup	Access this menu to setup static routes. There are four static routes for this protocol.
13	Default Dial-in Setup	Access this menu to setup default dial-in parameters so that your <i>Prestige</i> can be used as a dial-in server.
14	Dial-in User Setup	Setup remote dial-in user. <i>Prestige</i> has eight remote dial-in users.
21	Filter Set Configuration	Setup filters to provide security, call control, etc.
23	System Password	Access this menu to setup the password to access the SMT.
24	System Maintenance	Provides system status, diagnostics, firmware upload, etc.
99	Exit	To exit from SMT and return to the blank screen.

2.7 Changing the System Password

Follow these steps to change the default system password:

Step 1. Select option [23. System Password] in the Main Menu.

Step 2. When Menu 23 - System Password appears, as shown in Figure 2-5, type in your existing system password, i.e., **1234**, then press [Enter].

Figure 2-5. Menu 23.1 - System Password

Step 3. Enter your new system password and press [Enter].

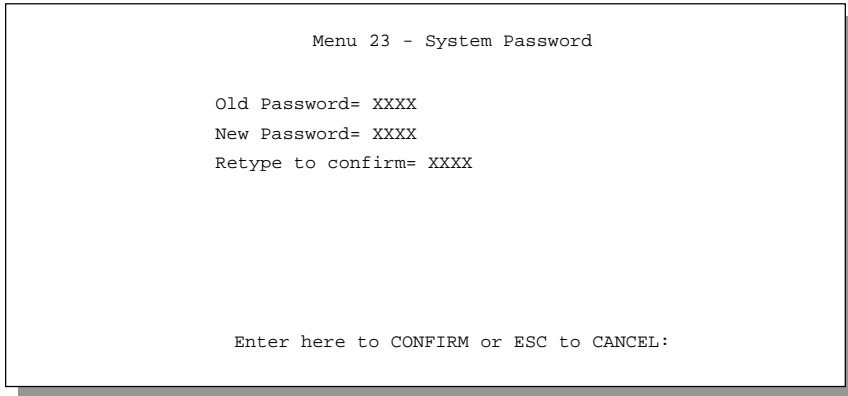

Step 4. Re-type your new system password for confirmation and press [Enter].



Note on Password Field

As you type the password, the screen displays an (X) for each character you type.

2.8 General Setup

The Menu 1 - General Setup contains administrative and system-related information.

To enter Menu 1 and fill in the required information, follow these steps:

- Step 1.** Select option [1. General Setup] in the Main Menu by typing 1 at the menu selection number prompt.
- Step 2.** The Menu 1 - General Setup screen appears, as shown in Figure 2-6. Fill in the required fields marked [?], as explained in Table 2-4.

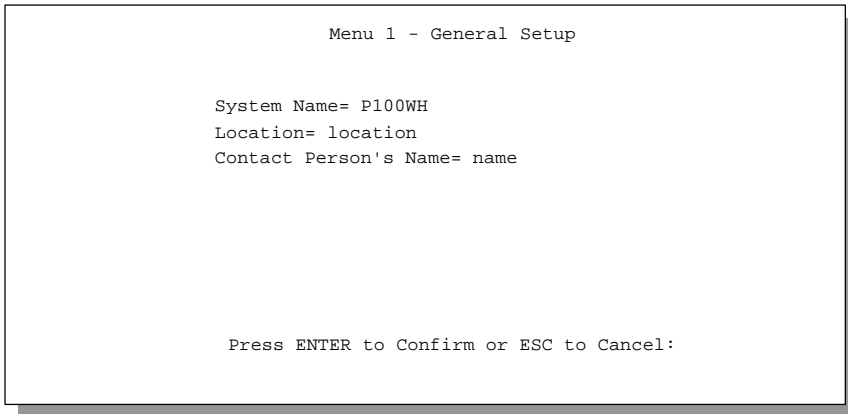

Table 2-4. General Setup Menu Fields

Field	Description
System Name	Choose a descriptive name for identification purposes. This name can be up to 8 alphanumeric characters long. Spaces are not allowed, but dashes "-" and underscores "_" are accepted.
Location (optional)	Enter the geographic location (up to 31 characters) of your <i>Prestige</i> .
Contact Person's Name (optional)	Enter the name (up to 8 characters) of the person in charge of this <i>Prestige</i> .

2.9 Prestige 100WH WAN Port Setup

This section describes how to configure the WAN port and the connected WAN device on your *Prestige* with Menu 2-WAN Port Setup. If advanced setup is required, go into Menu 2.1. When you are finished, press [Enter] in Menu 2.1 to save your configuration.

2.9.1 WAN Port Setup

To configure the WAN Port on the *Prestige*, follow these steps:

- Step 1.** Select option [2. WAN Port Setup] in the Main Menu by typing 2 at the menu selection number prompt.
- Step 2.** This will bring up Menu 2 –WAN Port Setup, as shown in Figure 2-7.

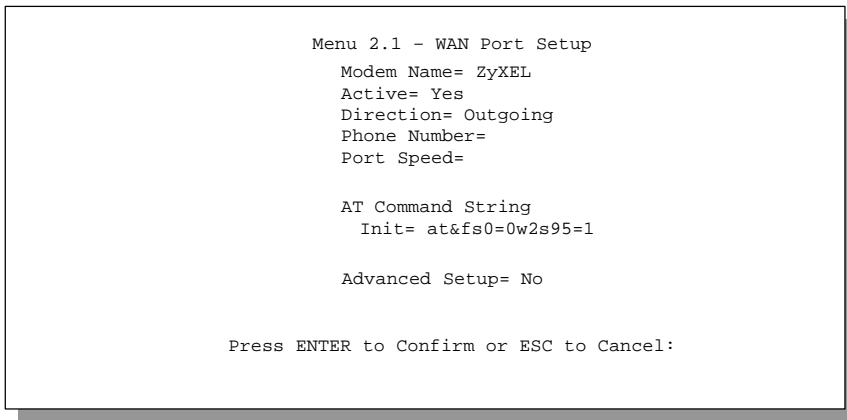

Figure 2-7. Menu 2.1 –WAN Port Setup

Table 2-5 describes how to configure the internal modem.

Table 2-5. WAN Port Setup Menu Fields

Field	Description
Modem Name	Enter a descriptive name for the WAN device on the WAN Port.
Active	Set to [Yes] to activate the WAN port.
Call Direction	Set the call direction for the WAN device.
Phone Number	Enter the telephone number assigned to your line by your telephone company. Note that your <i>Prestige</i> only accepts digits; do not include dashes and spaces in this field.
Port Speed	Press the space bar to select the speed of the RS-232 link between <i>Prestige</i> and the WAN device. The speed should be close to 4 times the speed of the WAN device. For example, 230400.
AT Command String: Init	Enter the AT commands to initialize the WAN device at <i>Prestige</i> start up. The string is sent to the WAN device again whenever it is modified. For example, [at&fs0=0w2s95=1].
Advanced Setup	To edit the Advanced Setup for this internal modem, move the cursor to this field, use the space bar to select [Yes] and press [Enter]. This will bring you to Menu 2.1.1 - Advanced WAN Setup.

The default initialization string tells a modem to load factory default (**&f**), not to answer any incoming call (**s0=0**), and to report line speed (**w2**) and in “**CONNECT speed**” format (**s95=1**). If you have an ISDN TA, please consult its documentation.

2.9.2 Advanced WAN Port Setup

The Advanced WAN Port Setup Menu allows you to configure the AT Commands for the WAN device and the call control parameters.

- Step 1.** In Menu 2.1, move the cursor to the Advanced Setup field and press the space bar to select [Yes], then press [Enter].
- Step 2.** When Menu 2.1.1 appears, fill in the appropriate AT commands and call control parameters, as shown in Figure 2-8.

```
Menu 2.1.1 - Advanced WAN Setup

AT Command Strings:
Dial=atdt
Drop= --++--ath
Answer= ata

Drop DTR When Hang Up= Yes

AT Response string:
CLID= NMBR
Called= TO
Speed= CONNECT

Call Control:
Dial Timeout(sec)= 60
Retry Counter= 0
Retry Interval(sec)= N/A
Drop Timeout(sec)= 20
Call Back Delay(sec)= 15

Enter here to CONFIRM or ESC to CANCEL:
```

Figure 2-8. Menu 2.1.1 - Advanced WAN Setup

Refer to Table 2-6 for details on how to fill in the AT commands fields.

Table 2-6. Advanced WAN Setup Fields

Field	Description
AT Command Strings:	
Dial	The AT commands needed to dial. The default setting in this field is [atdt].
Drop	The AT command needed to drop a call. The default setting in this field is [+++ath].
Answer	The AT command needed to answer an incoming call. The default setting in this field is [ata].
Drop DTR When Hang Up	If this field is set to [Yes], the <i>Prestige</i> will drop the DTR signal when hanging up a call.
AT Response Strings:	These strings specify the characters immediately preceding the various responses from the WAN device.
CLID	The string preceding the CLID (the number of calling party). The default setting in this field is NMBR.
Called ID	The string preceding the dialed number. The default setting in this field is TO.
Speed	The string preceding the DCE speed. The default setting in this field is CONNECT.
When you have completed this menu, press [Enter] to return to Menu 2.1.	

At Command Strings

For regular telephone lines, the default “Dial” string tells the modem that the line uses tone dialing. If your switch still requires pulse dialing, change the string to [atdp]. For ISDN lines, there are far more protocols and operational modes. Please consult the documentation of your TA, for you may need additional commands in both “Dial” and “Init” strings.

The default AT strings should work fine for the majority of modems. Please consult the documentation of your WAN device if you need to alter them for your specific situation, especially if you have an ISDN TA.

DTR Signal

The majority of WAN devices default to hanging up the current call when the DTR (Data Terminal Ready) signal is dropped by the DTE. When “Drop DTR When Hang Up” is set to yes, the Prestige will use this hardware signal to force the WAN device to hang up, in addition to issuing the drop command [ATH].

Response Strings

The response strings tell the Prestige the tags, or labels, immediately preceding the various call parameters sent from the WAN device. The response strings have not been standardized; please consult the documentation of your WAN device to find the correct tags.

Call Control Parameters

Table 2-7 below describes the call control parameters.

Table 2-7. Advanced Modem Setup Call Control Parameters

Field	Description
Dial Timeout (sec)	The <i>Prestige</i> will disconnect if it can not set up an outgoing call within the timeout value. The default in this field is [60] seconds.
Retry Count	How many times a busy or no-answer phone number is retried before it is put on the blacklist. The default in this field is [0] to disable the blacklist control.
Retry Interval (sec)	Elapsed time after a call fails before another call is retried. Applies before a phone number is blacklisted.
Drop Timeout (sec)	The <i>Prestige</i> will drop the DTR signal if it does not receive a positive response within this timeout period after it tells the WAN device to hang up. The default in this field is [20] seconds.
Call Back Delay (sec)	Elapsed time between dropping a callback request call and dialing a callback call. The default in this field is [15] seconds.

Chapter 3

Internet Access Application

This chapter shows you how to configure your *Prestige 100WH* for Internet Access.

3.1 Ethernet Setup

This section describes the Ethernet Setup Menu. From the Main Menu, enter 3, then the Menu 3- Ethernet Setup displays as shown in Figure 3-1.

Figure 3-1. Menu 3 - Ethernet Setup

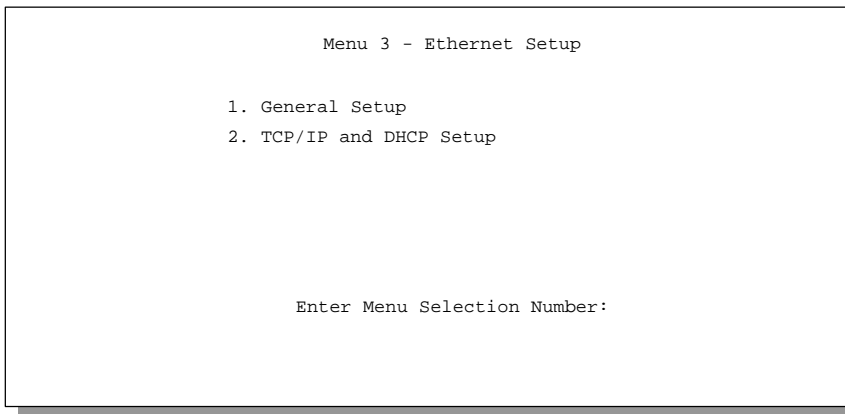

The General Setup menu allows you to define the filter sets that you wish to apply to your Ethernet traffic. From Menu 3 - Ethernet Setup, enter 1 to go to Menu 3.1 -General Ethernet Setup.

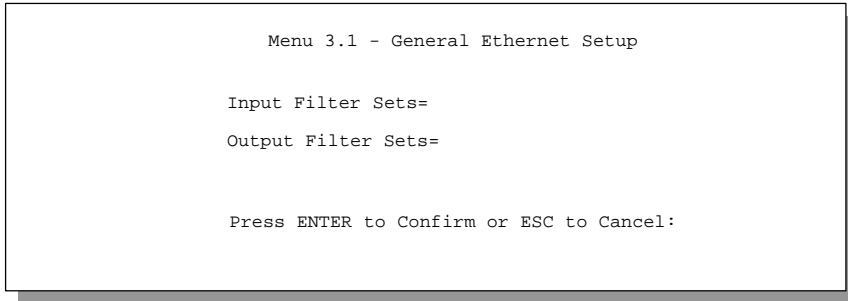

Figure 3-2. Menu 3.1 - General Ethernet Setup

Filters are not required for your *Prestige* to function properly. However, input and output filter sets may be useful to block certain packets, reduce traffic, and prevent a security breach on your Ethernet.

If you have a need for filters, read about *Chapter 7 - Filter Set Configuration*, then return to this menu to define the appropriate filter sets.

3.2 TCP/IP Ethernet and DHCP Setup

3.2.1 IP Address and Subnet Mask

The *Prestige* is pre-configured in the factory with an IP address of 192.168.1.1 and a subnet mask of 255.255.255.0 (Class C). This setup should work fine for the basic Internet access application. It is strongly recommend that you do not change them, unless your ISP or network administrator assigns you a block of registered IP addresses.



Note on IP Address Assignment

Every machine on your Ethernet network must have a unique IP address. Do not assign an arbitrary address to any machine on your network; or else your machines will not communicate to each other, let alone accessing the Internet.

3.2.2 RIP Setup

RIP (Routing Information Protocol) allows a router to exchange routing information with other routers. The **RIP Direction** field controls the sending and receiving of RIP packets. When set to both, the *Prestige* will broadcast its routing table periodically and incorporate the RIP information that it receives; when set to none, it will not send any RIP packets and will ignore any RIP packets received.

The **Version** field controls the format and the broadcasting method of the RIP packets that the *Prestige* sends (it recognizes both formats when receiving). RIP-1 is universally supported; but RIP-2 carries more information. RIP-1 is probably adequate for most networks, unless you have a unusual network topology.

Both RIP-2B and RIP-2M sends the routing data in RIP-2 format; the difference being that RIP-2B uses subnet broadcasting while RIP-2M uses multicasting. Multicasting can reduce the load on non-router machines since they generally do not listen to the RIP multicast address and so will not receive the RIP packets. However, if one router uses multicasting, then all routers on your network must use multicasting, as well.

By default, RIP direction is set to both and the version set to RIP-1.

3.2.3 DHCP Configuration

DHCP (Dynamic Host Configuration Protocol) allows the individual clients (workstations) to obtain the TCP/IP configuration at start-up from a centralized DHCP server. The *Prestige* has the DHCP server capability built-in and is enabled by default.

IP Pool Setup

The *Prestige* is pre-configured with a pool of 32 IP addresses starting from 192.168.1.33 to 192.168.1.64. This configuration leaves 31 IP addresses (excluding the *Prestige* itself) in the lower range for other server machines, e.g., server for mail, FTP, telnet, web, etc., that you may have.

DNS Server Address(es)

DNS (Domain Name System) is for mapping a domain name to its corresponding IP address and vice versa, e.g., the IP address of *www.zyxel.com* is 204.217.0.2. The DNS server(s) is extremely important because without it, you must know the IP address of a machine before you can access it. The DNS server address(es) that you enter in the DHCP setup is passed to the client machines along with the assigned IP address and subnet mask. Make sure that you obtain the IP address of the DNS server(s) from your ISP. Your workstations will need this information even if you don't use the *Prestige's* DHCP server.

3.2.4 More on IP Address and Subnet Mask

Similarly to the houses on a street that share a common street name, the machines on a LAN share one common network number.

Where you obtain your network number depends on your particular situation. If the ISP or your network administrator assigns you a block of registered IP addresses, follow their instructions in selecting the IP addresses and the subnet mask.

If you subscribe to an ISP and the ISP did not explicitly give you an IP network number, then most likely you have a single-user account. If this is the case, it is recommended that you select a network number from 192.168.0.0 to 192.168.255.0 (ignoring the trailing zero). The Internet Assigned Number Authority (IANA) reserved this block of addresses specifically for private use; please do *not* use any other number unless you are told otherwise. Let's say you select 192.168.1.0 as the network number; which covers 254 individual addresses, from 192.168.1.1 to 192.168.1.254 (zero and 255 are reserved). In other words, the first 3 numbers specify the network number while the last number identifies an individual workstation on that network.

Once you have decided on the network number, pick an IP address that is easy to remember, for example, 192.168.1.1, for your *Prestige*.

The subnet mask specifies the network number portion of an IP address. Your *Prestige* will compute the subnet mask automatically based on the IP address that you entered. You do not need to change the subnet mask computed by the *Prestige* unless instructed otherwise.

3.3 Configuring TCP/IP and DHCP

To edit Menu 3.2, select the menu option [3. Ethernet Setup] in the Main Menu. When Menu 3 appears, select the submenu option [2. TCP/IP and DHCP Setup] and press [Enter]. The screen now displays Menu 3.2 - TCP/IP and DHCP Ethernet Setup, as shown in Figure 3-3.

Figure 3-3. Menu 3.2 - TCP/IP and DHCP Ethernet Setup

```
Menu 3.2 - TCP/IP and DHCP Ethernet Setup

DHCP Setup:
  DHCP= Server
  Client IP Pool Starting Address= 192.168.1.33
  Size of Client IP Pool= 32
  Primary DNS Server= N/A
  Secondary DNS Server= N/A

TCP/IP Setup:
  IP Address= 192.68.1.1
  IP Subnet Mask= 255.255.255.0
  RIP Direction= Both
  Version= RIP-1

Enter here to CONFIRM or ESC to CANCEL:

Press Space Bar to Toggle.
```

Follow the instructions in Table 3-1.on how to configure the DHCP fields.

Table 3-1. DHCP Ethernet Setup Menu Fields

Field	Description
DHCP	This field determines the mode of DHCP support. If set to [None], DHCP will not be used. If it is set to [Server], your <i>Prestige</i> will act as a DHCP server. The default in this field is [Server].
If DHCP=Server:	When DHCP is used, the following four items need to be set:
Client IP Pool Starting Address	The Client IP Pool Starting Address gives the first address in the pool. The default in this field is 192.168.1.33
Size of Client IP Pool	The count of the IP addresses in the pool. The default in this field is 32.
Primary and Secondary DNS Server	Enter the IP address of the DNS server(s) provided by your ISP or network administrator.

Table 3-2 contains instructions on how to configure your *Prestige* for TCP/IP Ethernet Setup.

Table 3-2. TCP/IP Ethernet Setup Menu Fields

Field	Description
TCP/IP Setup	
IP Address	Enter the IP address of your <i>Prestige</i> in dotted decimal notation. The default in this field is 192.168.1.1.
IP Subnet Mask	Enter the subnet mask of your <i>Prestige</i> . The default in this field is 255.255.255.0.
RIP Direction	This parameter determines how your <i>Prestige</i> handles RIP traffic (In/Out/both/none). The default in this field is [Both].
Version	Version of RIP packets sent by the <i>Prestige</i> . The default in this field is RIP-1.
When you have completed this menu, press [Enter] at the prompt [Press ENTER to Confirm...] to save your configuration, or press [Esc] at any time to cancel.	

3.4 Internet Access Configuration

Menu 4 of the SMT allows you to enter the Internet access configuration in one screen. Menu 4 is actually a simplified setup for one of the four available remote nodes that you can access through menu 11. Before you configure your *Prestige* for Internet Access, you need to collect your Internet account information from your ISP. You can use Table 3-3 to record your Internet Account Information.

Table 3-3. Internet Account Information

Internet Account Information	Write your account information here
IP Address of the ISP's Gateway (Optional)	
Telephone Number(s) of your ISP	
Login Name	
Password	
DNS Server Address(es)	

From the Main Menu, enter option [4. Internet Access Setup] to go to Menu 4 - Internet Access Setup, as displayed in Figure 3-4.

Figure 3-4. Menu 4 - Internet Access Setup

```

Menu 4 - Internet Access Setup
ISP's Name= ChangeMe
ISP Gateway IP Addr=
Pri Phone #= 1234
Sec Phone #=
My Login=
My Password= *****
Single User Account= Yes
    Local IP Addr= 0.0.0.0
    Server IP Addr= 0.0.0.0
Edit Script Options= No

Enter here to CONFIRM or ESC to CANCEL:

```

Table 3-4 contain instructions on how to configure your *Prestige* for Internet Access.

Table 3-4. Internet Access Setup Menu Fields

Field	Description
ISP's Name	Enter the name of your Internet Service Provider. (This information is for identification purposes only.)
ISP IP Addr (optional)	Enter the IP Address of the remote gateway at the ISP's site. If you do not have this data, just leave it blank.
Pri(mary) Phone # (required)	The first number your <i>Prestige</i> will dial to connect to the ISP.
Sec(ondary) Phone # (optional)	If the Primary Phone number is busy or does not answer, your <i>Prestige</i> will call the Secondary Phone number if available.
My Login Name (required)	Enter the login name assigned to you by your ISP.
My Password (required)	Enter the password associated with the login name above. Note that this login name/password pair is only for your <i>Prestige</i> to connect to the ISP's gateway. When you use TCP/IP applications (for example, FTP) to access the Internet from your workstation, you will need a separate login name and password for each server.
Single User Account	See Section 3.5 for detailed discussion on the Single User Account feature. The default in this field is Yes.
Local IP Addr:	If your ISP assigns you a static IP address, enter it in this field; otherwise, leave it as 0.0.0.0. (default)
Server IP Addr:	If you have a server that you want it to be accessible from the outside, enter its local IP address in this field; otherwise, leave it as 0.0.0.0. (default)
Edit Script Options	To edit the parameters, select [Yes] and press [Enter]. This will bring you to Menu 4.1 - Remote Node Script Options.
Press [Enter] at the prompt [Press ENTER to Confirm...] to save your configuration, or press [Esc] at any time to cancel.	

At this point, the SMT will ask if you wish to test the Internet connection. If you answer [y]

for yes, your *Prestige* will call the ISP to test the Internet setup. If the test fails, note the error message that you receive on screen and take the appropriate troubleshooting steps.

3.5 Single User Account

Typically, if there are multiple users on the LAN wanting to access the Internet, they will have to subscribe to multiple IP addresses from the ISP, which is generally more expensive than a single user account.

The Single User Account (SUA) feature allows multiple workstations on your LAN to have access to the Internet, but still only pay for one IP address, thus saving significantly on subscription fees. (Check with your ISP before you enable this feature).

Figure 3-5 illustrates a typical Single User Account topology.

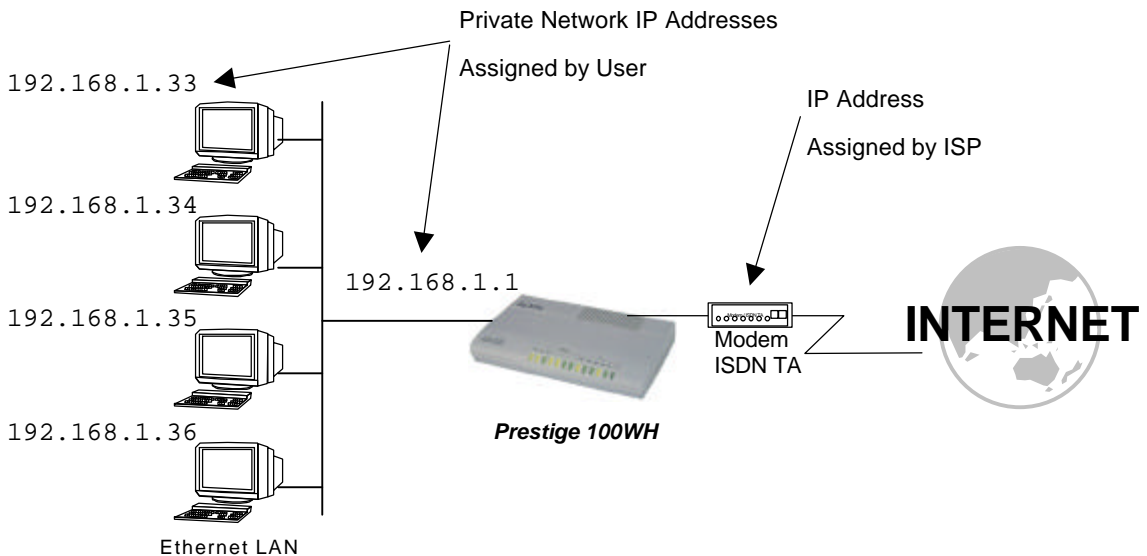

Figure 3-5. Single User Account Topology

The Single User Account feature may also be used to connect to remote networks other than the Internet. For example, this feature can be used to simplify the allocation of IP addresses when connecting branch offices to the corporate network.

The IP address for the SUA can be either fixed or dynamically assigned by the ISP (or another remote node). In addition, you can also configure a server (for example, a Web server) on your local network and make it accessible to outside users.

If you do not set a server IP address, SUA offers the additional benefit of firewall protection. With SUA, all incoming inquiries will be filtered out by your *Prestige* if no server is defined. This can prevent intruders from probing your network.

Your *Prestige* accomplishes this address sharing by translating the internal LAN IP addresses to a single address that is globally unique on the Internet. For more information on IP address translation, refer to RFC 1631, *The IP Network Address Translator (NAT)*.

3.5.1 Advantages of SUA

The advantages of SUA include

- SUA is an ideal cost-effective solution for small offices with a few tens of hosts to concurrently access the Internet or another remote TCP/IP network.
- SUA can provide one server to be accessible to the outside world.
- SUA can provide firewall protection if you do not configure a server. All incoming inquiries will be filtered out by your *Prestige*, protecting your network.
- UDP and TCP datagrams can be routed. In addition, partial ICMP is supported.

Figure 3-5 above shows an example of a small office connecting to the Internet via SUA.

3.5.2 Configuration for Single User Account

The steps for configuring your *Prestige* for Single User Account are identical to the conventional Internet Access (See configuration instructions in Table 3-4) with the exception that you need to fill in three extra fields in Menu 4 - Internet Access Setup, as shown in Figure 3-6.

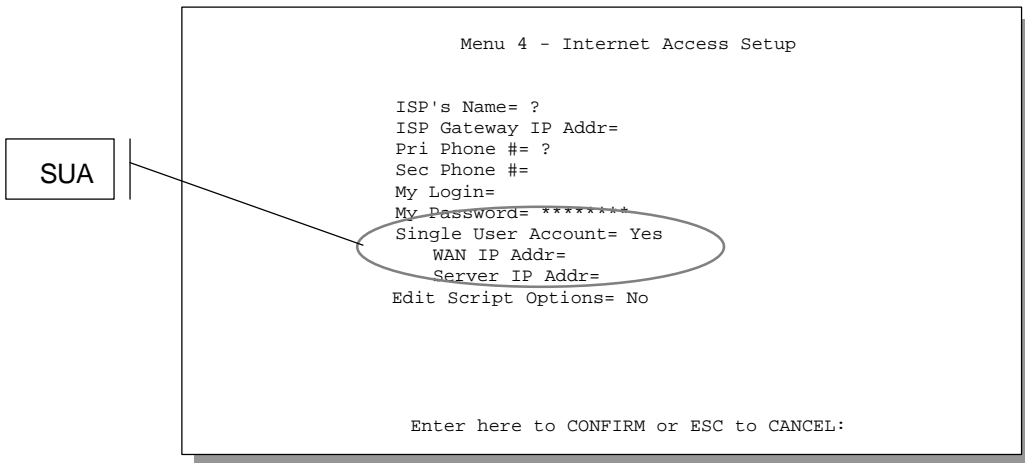

Figure 3-6. Menu 4 - Internet Access Setup for Single User Account

To enable the SUA feature in Menu 4, move the cursor to the [Single User Account] field and select [Yes] (or [No] to disable SUA). Then follow the instructions on how to configure the SUA fields in Table 3-5.

Table 3-5. Single User Account Menu Fields

Field	Description
Single User Account	Select [Yes] to enable SUA.
WAN IP Addr.	If your ISP assigns you a dynamic IP address, enter [0.0.0.0] here. If your ISP assigns you a static IP address, enter that IP address here.
Server IP Addr.	If you want to make an inside server (for example, a Web server) accessible to outside users, enter that server's LAN IP address here.
Press [Enter] at the message [Press ENTER to Confirm ...] to save your configuration, or press [Esc] at any time to cancel.	

Please note that if you have an inside server that you want it to be visible to the outside world, then it must have a fixed IP address and not depend on a DHCP server to assign it a dynamic address.

At this point, your *Prestige* will ask if you wish to test the Internet connection. If you select [Yes], your *Prestige* will call the ISP and test the connection. If the test fails, note the error message that you receive and take the appropriate troubleshooting steps.

3.6 Configuring Backup ISP Accounts

If you have more than one ISP account, you can configure a remote node for the secondary account as a backup instead of modifying Menu 4 all the time. The SUA feature can be enabled for all of these accounts, making it convenient to switch to another ISP when one is not available.

3.6.1 Configure a Backup ISP

To configure a backup ISP Account, follow these steps:

- Step 1.** Configure your primary ISP using Menu 4, as described earlier in this chapter.
- Step 2.** Enter Menu 11, then select the number of an unused remote node.
- Step 3.** In Menu 11.1, choose a name for your backup ISP account, then set the Active field to [No], and enter your outgoing login name, password, and phone number(s). The Remote IP Address field should be set to [1.1.1.1].
- Step 4.** In Menu 11.3, set the remote node's subnet mask to [0.0.0.0], and set RIP to [None].
- Step 5.** Save the new configuration.

Please note that the remote IP address of 1.1.1.1 is only a place-holder to avoid conflicting with the IP address of the primary ISP, which is implicitly set at 0.0.0.0. When combined with the subnet mask of 0.0.0.0, it creates a default route identical to the one derived from the primary ISP when this remote node is activated.

3.6.2 To Switch ISP

Once you have done this, if you need to switch from your primary ISP to a backup ISP follow these steps:

- Step 1.** Enter Menu 11 and select your Primary ISP.
- Step 2.** In Menu 11.1, set the Active field to [No].
- Step 3.** Enter Menu 11 again and select your Backup ISP.
- Step 4.** In Menu 11.1, set the Active field to [Yes].

You will now be able to access the Internet through the backup ISP remote node.

3.7 Editing Script Options

For some ISP, text login is required before it will start PPP negotiation. The *Prestige* provides a script facility for this purpose. The script has six programmable sets; each is composed of an ‘Expect’ string and a ‘Send’ string. After matching the message from the server to the ‘Expect’ string, the *Prestige* returns the set’s ‘Send’ string to the server.

For instance, a typical login sequence starts with the server printing a banner, a login prompt for you to enter the user name and a password prompt to enter the password:

```
Welcome to Acme, Inc.  
Login: myLogin  
Password:
```

To handle the first prompt, you specify “ogin: ” as the ‘Expect’ string and “myLogin” as the ‘Send’ string in set 1. The reason for leaving out the leading “L” is to avoid having to know exactly whether it is upper or lower case. Similarly, you specify “word: ” as the ‘Expect’ string and your password as the ‘Send’ string for the second prompt in set 2.

Please note that the ordering of the sets is significant, i.e., starting from set 1, the *Prestige* will wait until the ‘Expect’ string is matched before it proceeds to set 2, and so on for the rest of the script. When both the ‘Expect’ and the ‘Send’ fields of the current set are empty, the *Prestige* will terminate the script processing and start PPP negotiation. This implies two things: first, the sets must be contiguous; the sets after an empty one are ignored. Second, the last set should match the final message sent by the server. For instance, if the server prints

```
Login successful.  
Starting PPP...
```

after you enter the password, then you should create a third set to match the final “PPP...”, but without a “Send” string. Otherwise, the *Prestige* will start PPP prematurely right after sending your password to the server.

If there are errors in the script and it gets stuck at a set for longer than the “Dial Timeout” in menu 2 (default 60 seconds), the *Prestige* will timeout and drop the line. To debug a script, go to Menu 24.4 to initiate a manual call and watch the trace display to see if the sequence of messages and prompts from the server differs from what you expect.

The Internet Setup Script menu is shown in Figure 3-7.

```

Menu 4.1 - Internet Setup Script

Active= No

Set 1:                               Set 5:
Expect=                               Expect=
Send=                                 Send=
Set 2:                               Set 6:
Expect=                               Expect=
Send=                                 Send=
Set 3:
Expect=
Send=
Set 4:
Expect=
Send=

Press ENTER to CONFIRM or ESC to CANCEL:

Press Space Bar to Toggle.
    
```

Figure 3-7. Menu 4.1 - Internet Setup Script

The following Table 3-6 describes each field in Menu 4.1 – Internet Setup Script.

Table 3-6. Internet Setup Script Menu Fields

Field	Description
Active	Press the space bar to toggle between [Yes] and [No].
Set 1-6: Expect	Enter an Expect string to capture. After capturing the Expect string, the <i>Prestige</i> will send out the string in the [Send] field.
Set 1-6: Send	Enter a string to send out after the Expect string is matched.
Press [Enter] at the message [Press ENTER to Confirm...] to save your script, or press [Esc] at any time to cancel.	

Chapter 4

Remote Node Configuration

A remote node is required for placing calls to a remote gateway. A remote node represents both a remote gateway and the network behind it, across a WAN connection. Please note that when you use Menu 4 to configure the Internet access, you are actually configuring one of the four remote nodes available in your *Prestige*. Once a remote node is configured properly, traffic to the remote network will trigger your *Prestige* to make a call automatically (i.e., Dial On Demand).

4.1 Remote Node Setup

This section describes the configuration of protocol-independent parameters for the remote node.

4.1.1 Remote Node Profile

To configure the remote node parameters, follow these steps:

- Step 1.** From the Main Menu, select menu option [11. Remote Node Setup]
- Step 2.** When Menu 11 appears, as shown in Figure 4-1, enter the number of the remote node (1-4) that you wish to configure.

Figure 4-1. Menu 11 - Remote Node Setup

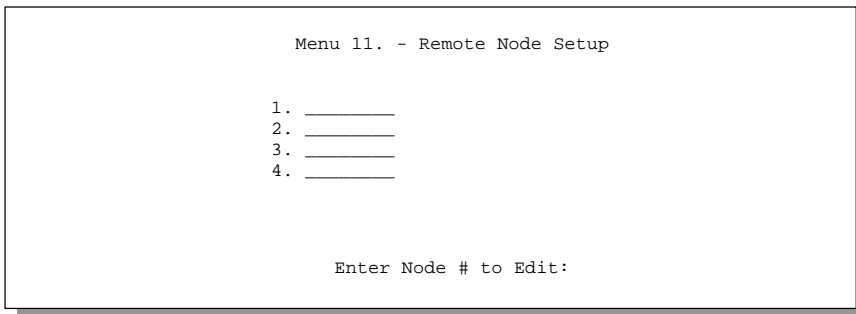

```
Menu 11. - Remote Node Setup

1. _____
2. _____
3. _____
4. _____

Enter Node # to Edit:
```

Step 3. When Submenu 11.1. - Remote Node Profile appears, as shown in Figure 4-2, follow the instructions in Table 4-1 to configure a remote node.

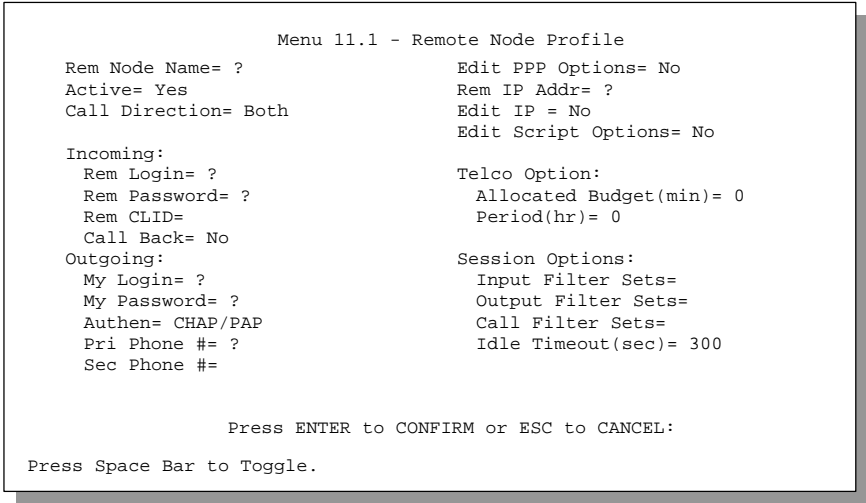

Figure 4-2. Menu 11.1 - Remote Node Profile for Dial-up Line Applications

Table 4-1 contains the instructions on how to configure the remote node menu.

Table 4-1. Remote Node Profile Menu Fields for Dial-up Line Applications

Field	Description
Rem Node Name	This is a required field. Enter a descriptive name for the remote node, for example, Corp. This field can support up to eight characters. This name must be unique from any other remote node name or dial-in user name.
Active	Press the space bar to toggle between [Yes] and [No]. Inactive nodes are displayed with a minus sign (-) at the beginning of the name in Menu 11.

Table 4-1. Remote Node Profile Menu Fields for Dial-up Line Applications (continued)

Field	Description
Call Direction	<ul style="list-style-type: none"> ● If this parameter is set to [Both], your <i>Prestige</i> can both place and receive calls to/from this remote node. ● If set to [Incoming], your <i>Prestige</i> will not place a call to this remote node. ● If set to [Outgoing], your <i>Prestige</i> will drop an incoming call from this remote node. <p>Several other fields in this menu depend on this parameter. For example, in order to enable [Call Back], the Call Direction must be [Both].</p>
Incoming: Rem Login	<p>Enter the login name that this remote node uses to call into your <i>Prestige</i>.</p> <p>The login name in this field combined with the Rem Password will be used to authenticate the incoming calls from this node.</p>
Incoming: Rem Password	<p>Enter the password used when this remote node calls into your <i>Prestige</i>.</p>
Incoming: Rem CLID	<p>This field is active only if [Call Direction] is either [Both] or [Incoming]. Otherwise, an [N/A] appears in the field.</p> <p>This is the Calling Line ID (the telephone number of the calling party) of this remote node.</p> <p>If you enable the CLID Authen field in Menu 13 - Default Dial In, your <i>Prestige</i> will check the CLID in the incoming call against all CLID in the database. If none of them match and the CLID Authen is Required, the call will be rejected.</p>

Table 4-1. Remote Node Profile Menu Fields for Dial-up Line Applications (continued)

Field	Description
Incoming: Call Back	<p>This field will be valid only if [Call Direction] is [Both]. Otherwise, an [N/A] appears in the field.</p> <p>This field determines whether or not your <i>Prestige</i> will call back after receiving a call from this remote node.</p> <p>If this option is enabled, your <i>Prestige</i> will disconnect the initial call from this node and call it back at the Outgoing Primary Phone Number (see below).</p>
Outgoing: My Login Name	<p>This is a required field if [Call Direction] is either [Both] or [Outgoing]. Enter the login name when calling this remote node.</p>
Outgoing: My Password	<p>This is a required field if [Call Direction] is either [Both] or [Outgoing]. Enter the password for your <i>Prestige</i> when it calls this remote node.</p>
Outgoing: Authen	<p>This field sets the authentication protocol allowable when the <i>Prestige</i> calls this remote node.</p> <p>Options for this field are:</p> <ul style="list-style-type: none"> ● CHAP/PAP - Your <i>Prestige</i> will agree to either CHAP or PAP when requested by the remote node. ● CHAP – Use CHAP only ● PAP – Use PAP only.
Outgoing: Pri(mary) Sec(ondary) Phone Numbers	<p>Both the Primary Phone number and the Secondary Phone number refer to the number that your <i>Prestige</i> will dial to connect to the remote node. Your <i>Prestige</i> will always call the remote node using the Primary Phone number first.</p> <p>If the Primary Phone number is busy or does not answer, your <i>Prestige</i> will call the Secondary Phone number if available.</p> <p>Some areas require dialing the pound sign # before the phone number for local calls. A # symbol may be included at the beginning of the phone numbers.</p>

Table 4-1. Remote Node Profile Menu Fields for Dial-up Line Applications (continued)

Field	Description
Edit PPP Options	To edit the PPP options for this remote node, move the cursor to this field, use the space bar to select [Yes] and press [Enter] . This will bring you to Menu 11.2 - remote node PPP Options. For more information on configuring PPP options, see the section Editing PPP Options.
Rem IP Addr	This is a required field. Enter the IP address of the remote gateway.
Edit IP	To edit the parameters, select [Yes] and press [Enter]. This will bring you to Menu 11.3 - Remote node Network Layer Options. For more information on this screen, refer to the <i>Chapter 5</i> pertaining to the TCP/IP protocol.
Edit Script Options	To edit the parameters, select [Yes] and press [Enter]. This will bring you to Menu 11.4 - Remote node Script Options. See Section 3.7 <i>Editing Script Options</i> for details.
Telco Options: Allocated Budget (min) Period (hr)	 This field sets a budget outgoing call time for the remote node. The default for this field is [0] for no budget control. This field sets the time interval to reset the above outgoing call budget control.
Session Options: Input Filter Sets, Output Filter Sets and Call Filter Sets	 In these fields, select which filter set(s) you would like to apply to the incoming and outgoing traffic between this remote node and your <i>Prestige</i> . You can choose from 12 different filter sets. In addition, you can link up to 4 filter sets together for further customization (for example, 1, 5, 9, 12). The default is Blank. Note that spaces are accepted in this field. For more information on customizing your filter sets, see <i>Chapter 7</i> . The default is blank, that is, no filters defined.

Table 4-1. Remote Node Profile Menu Fields for Dial-up Line Applications (continued)

Field	Description
Session Option: Idle Timeout (sec)	The Idle Timeout specifies the number of idle seconds that elapses before the remote node is automatically disconnected. The idle timer is reset whenever there is data traffic from the <i>Prestige</i> ; however, administrative packets such as RIP are not counted as data. The default is 300 seconds (5 minutes). The idle timeout mechanism is disabled if the value is set to 0, i.e., the connection will stay up indefinitely.
Once you have completed filling in Menu 11.1.1 – Remote Node Profile, press [Enter] at the message [Press ENTER to Confirm ...] to save your configuration, or press [Esc] at any time to cancel.	

4.1.2 Editing PPP Options

To edit the remote node PPP Options, move the cursor to the [Edit PPP Options] field in Menu 11.1 - Remote Node Profile, and use the space bar to toggle and select [Yes], then press [Enter]. Menu 11.2 appears as shown in Figure 4-3.

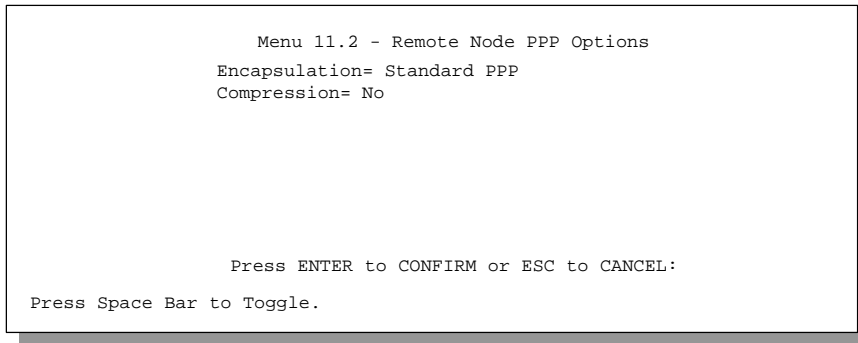

Figure 4-3. Menu 11.2 - Remote Node PPP Options

Table 4-2 describes the Remote Node PPP Options Menu, and contains instructions on how to configure the PPP options fields.

Table 4-2. Remote Node PPP Options Menu Fields

Field	Description
Encapsulation	Select the vendor-specific encapsulation for the link. There are two options in this field. <ul style="list-style-type: none"> ● Standard PPP - Standard PPP options will be used. ● CISCO PPP - Cisco PPP will be used.
Compression	Turn on the Stac Compression. The default for this field is [Off].
Once you have completed filling in Menu 11.2 - Remote Node PPP Options, press [Enter] at the message [Press ENTER to Confirm...] to save your configuration, or press [Esc] at any time to cancel.	

4.2 Outgoing Authentication Protocol

Generally speaking, you should employ the strongest authentication protocol possible, for obvious reasons. However, some vendor's implementation includes specific authentication protocol in the user profile. It will disconnect if the negotiated protocol is different from that in the user profile, even when the negotiated protocol is stronger than specified. If you encounter the case where the peer disconnects right after a successful authentication, please make sure that you specify the correct authentication protocol when connecting to such an implementation.

Chapter 5

Remote Node TCP/IP Configuration

This chapter shows you how to configure the TCP/IP parameters of a remote node for LAN-to-LAN application.

5.1 LAN-to-LAN Application

A typical LAN-to-LAN application is to use your *Prestige* to call from a branch office to the headquarters, as depicted in the following Figure 5-1.

Figure 5-1. LAN-to-LAN Application with TCP/IP

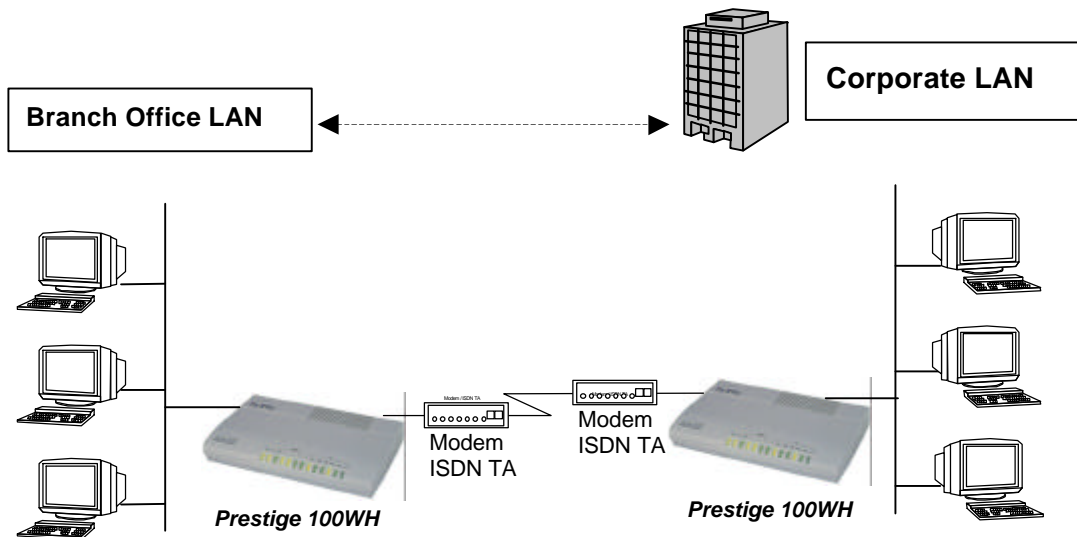

For the branch office, you need to configure a remote node in order to dial out to the headquarters. Additionally, you may also need to enter static routes if some services reside beyond the immediate remote LAN.

5.1.1 Remote Node Setup

Follow the procedure in *Chapter 5 - Remote node Configuration for LAN-to-LAN* to fill the protocol-independent parameters in Menu 11 - Remote Node Profile. For the protocol-dependent parameters, follow the instructions below. If you are configuring your *Prestige* to receive an incoming call, you also need to set the default dial-in parameters in Menu 13.

To edit Menu 11.3 - Remote Node Network Layer Options shown in Figure 5-2, follow these instructions:

- In Menu 11.1 - Remote Node Profile, move the cursor to the [Edit IP] field, then press the space bar to toggle and set the value to [Yes], then press [Enter] to edit Menu 11.3 - Network Layer Options.

Figure 5-2. Menu 11.3- Remote Node Network Layer Options for TCP/IP

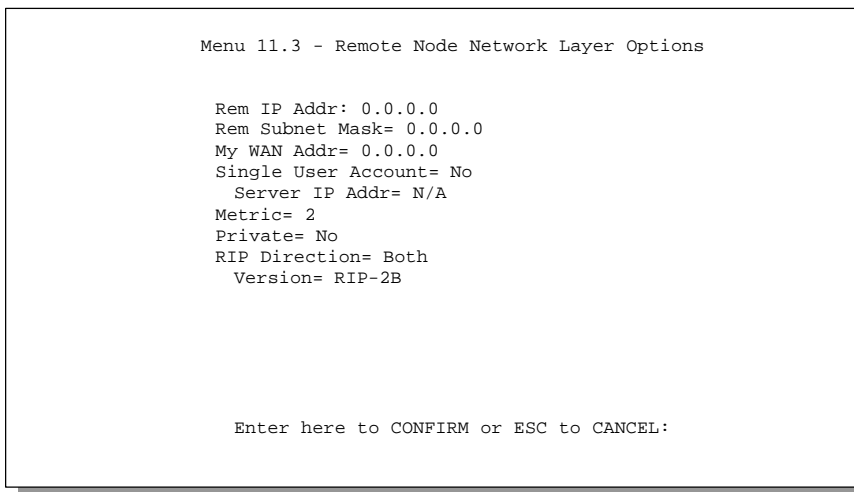

Applications

The following diagram in Figure 5-3 is an example to help understand the field of My Wan Address in Menu 11.3.

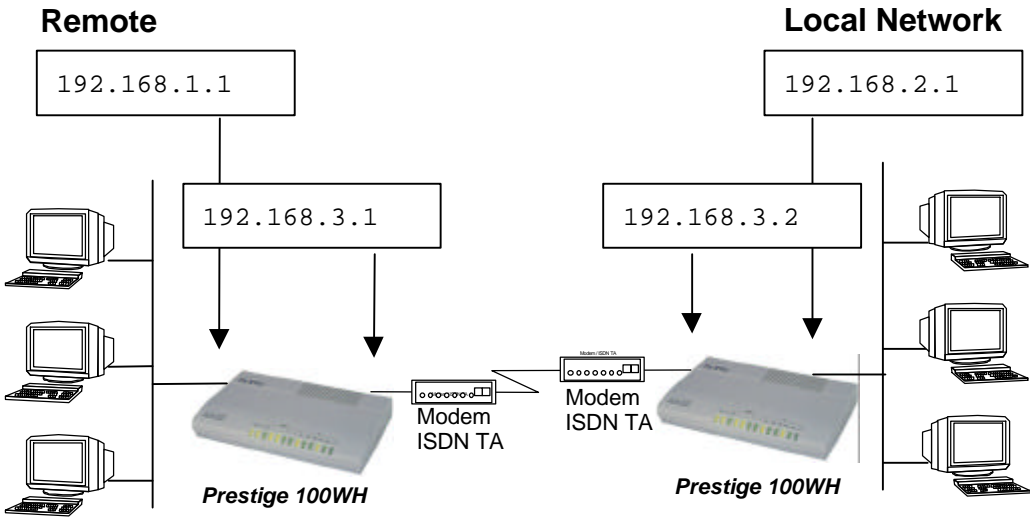

Figure 5-3. Sample IP Addresses for a LAN-to-LAN Connection with TCP/IP

The following Table 5-1 describes the Remote Node Profile and Remote Node Network Layer Options for a TCP/IP configuration.

Table 5-1. Remote Node Network Layer Options for a TCP/IP Configuration

Field	Description
Rem IP Address	This will show the IP address you entered for this remote node in the previous menu.
Rem IP Subnet Mask	Enter the subnet mask for the remote network.
My WAN Addr	<p>Some implementations, especially the UNIX derivatives, require hosts on both ends of the link to have separate addresses from the LAN, and that the addresses must have the same network number. If this is the case, enter the IP address assigned to the WAN port of your <i>Prestige</i>.</p> <p>Note that this is the address assigned to your local <i>Prestige</i>, not the remote router. Please see Figure 5-3 for an explanation of My WAN Addr. With Sample IP Addresses.</p>
Single User Account	This field should be set to [Yes] to enable the Single User Account (Network Address Translation) feature for this site. Use the space bar to toggle between [Yes] and [No]. See <i>Chapter 3 - Internet Access Application</i> for more information on the Single User Account feature.
Server IP address	If you are using the Single User Account feature and you want to make a server on your LAN (for example, a Web server) accessible to outside users, enter that servers IP address here.
Metric	The metric represents the “cost” of transmission for routing purposes. IP routing uses hop count as the measurement of cost, with a minimum of [1] for directly connected networks. Enter a number that approximates the cost for this link. The number need not be precise, but it must be between [1] and [16]. In practice, [2] or [3] is usually a good number.
Private	This parameter determines if the <i>Prestige</i> will include the route to this remote node in its RIP broadcasts. If set to [Yes], this route is kept private and not included in RIP broadcast. If [No], the route to this remote node will be propagated to other hosts through RIP broadcasts.

Table 5-1. Remote Node Network Layer Options for a TCP/IP Configuration (continued)

Field	Description
RIP	<p>This parameter determines how your <i>Prestige</i> handles RIP (Routing Information Protocol), and the default is [Both].</p> <p>If set to [Both], your <i>Prestige</i> will broadcast its routing table on the WAN, and incorporate RIP broadcasts by the other router into its routing table.</p> <p>If set to [In Only], your <i>Prestige</i> will not broadcast its routing table on the WAN.</p> <p>If set to [Out Only], your <i>Prestige</i> will broadcast its routing table but ignores any RIP broadcast packets that it receives.</p> <p>If set to [None], your <i>Prestige</i> will not participate in any RIP exchange with other routers.</p> <p>Usually, you should leave this parameter to [Both] and let RIP propagate the routing information automatically if you have multiple LANs behind the <i>Prestige</i>. If you have only a single LAN, turn RIP off to reduce the traffic.</p>
Version	<p>The parameter specifies the RIP version and method of broadcasting when sending routing table. The <i>Prestige</i> recognizes both versions when receiving. Please see <i>section 3.2.2 RIP Setup</i> for a detailed discussion on RIP versions.</p>
<p>Once you have completed filling in the Network Layer Options Menu, press [Enter] to return to Menu 11. Press [Enter] at the message [Press ENTER to Confirm...] to save your configuration, or press [Esc] at any time to cancel.</p>	

Remote IP Address

The *Prestige* compares the negotiated remote IP network number against the configured network number after IPCP (IP Control Protocol) negotiation. The network number is computed by ANDing the IP address with the subnet mask, e.g., if the IP address is 192.168.1.1 and the subnet mask is 255.255.255.0, then the network number is 192.168.1.0.

The comparison of the negotiated and configured IP network numbers (as opposed to IP addresses) means that, as long as the resulting network numbers agree, you don't have to know the exact IP address of the remote gateway. On the other hand, the *Prestige* will disconnect if the negotiated network number is different from the configured, since it implies the routing information derived from the remote node is incorrect.

5.1.2 Static Route Setup

Static routes tell the *Prestige* routing information that it cannot learn automatically through other means. This can arise in cases where RIP is disabled on the LAN or a remote network is beyond the one that is directly connected to a remote node.

Each remote node specifies only the network to which the gateway is directly connected, and the *Prestige* has no knowledge of the networks beyond. For instance, the *Prestige* knows about network N2 in the following diagram through remote node R. However, the *Prestige* is unable to route a packet to network N3 because it doesn't know that there is a route through remote node R. The static routes are for you to tell the *Prestige* about the networks beyond the remote nodes.

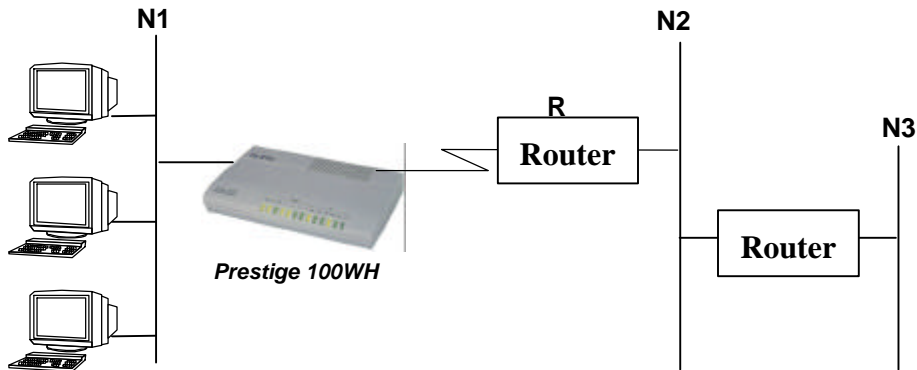

Figure 5-4. Example of Static Routing Topology

To create a static route for IP, use Menu 12, Static Route Setup, as displayed in Figure 5-5.

```
Menu 12 - Static Route Setup

1. sroute
2. _____
3. _____
4. _____

Enter Selection Number:
```

Figure 5-5. Menu 12 - Static Route Setup

From Menu 12, select one of the four possible IP Static Routes (no. 1-4), this will open Menu 12.2 - Edit IP Static Route, as shown in Figure 5-6.

```
Menu 12.1 - Edit IP Static Route

Route #: 1
Route Name= sroute
Active= Yes
Destination IP Address= 192.68.135.1
IP Subnet Mask= 255.255.255.0
Gateway IP Address= 204.247.135.1
Metric= 2
Private= No

Press ENTER to Confirm or ESC to Cancel:
```

Figure 5-6. Menu 12.1 - Edit IP Static Route

Table 5-2 describes the fields for Menu 12.1 - Edit IP Static Route Setup.

Table 5-2. Edit IP Static Route Menu Fields

Field	Description
Route Name	Enter a descriptive name for this route. This is for identification purpose only.
Active	This field allows you to activate/deactivate this static route.
Destination IP Address	This parameter specifies the IP address of the remote network.
IP Subnet Mask	Enter the subnet mask for this destination. Follow the discussion on IP subnet mask in this chapter. If you need to specify a route to a single host, use a subnet mask of 255.255.255.255 in this field.
Gateway IP Address	Enter the IP address of the gateway. The gateway is an immediate neighbor of your <i>Prestige</i> that will forward the packet to the destination. On the LAN, the gateway must be a router on the same segment as your <i>Prestige</i> ; over WAN, the gateway must be the IP address of one of the Remote nodes.
Metric	Same meaning as those in the Remote node Setup (See Table 5-1).
Private	Same meaning as those in the Remote node Setup (See Table 5-1).
Once you have completed filling in this menu, press [Enter] at the message [Press ENTER to Confirm...] to save your configuration, or press [Esc] at any time to cancel.	

Chapter 6

Dial-in Server Applications

You can configure your *Prestige* to receive calls from remote dial-in users (for example, Telecommuters) and remote nodes. There are several differences between dial-in users and remote nodes, as summarized in Table 6-1.

Table 6-1. Remote Dial-in Users/Remote Nodes Comparison Chart

Remote Dial-in Users	Remote nodes
Your <i>Prestige</i> will only answer calls from dial-in users.	Your <i>Prestige</i> can make calls to or answer calls from the remote node.
All dial-in users share one common set of parameters, as defined in the Default Dial In Setup (Menu 13).	Each remote node can have its own set of parameters such as call budget, etc.

This chapter discusses how to setup Default Dial-in parameters for both remote node and remote dial-in users. The following sections give two examples of how your *Prestige* can be configured as a dial-in server for both.

6.1 Telecommuting

Telecommuting enables people to work at remote sites and yet still have access to the resources in the business office. Typically, a telecommuter will use a client workstation with TCP/IP and dial-out capabilities (for example, a Windows 95 PC or a Macintosh) connected to a modem. For telecommuters to call in to your LAN, you need to configure a dial-in user profile for each telecommuter. Additionally, you need to configure the Default Dial-In Setup to set the operational parameters for all dial-in users. You can configure up to eight dial-in users for your *Prestige*.

An example of telecommuting, is shown in Figure 6-1.

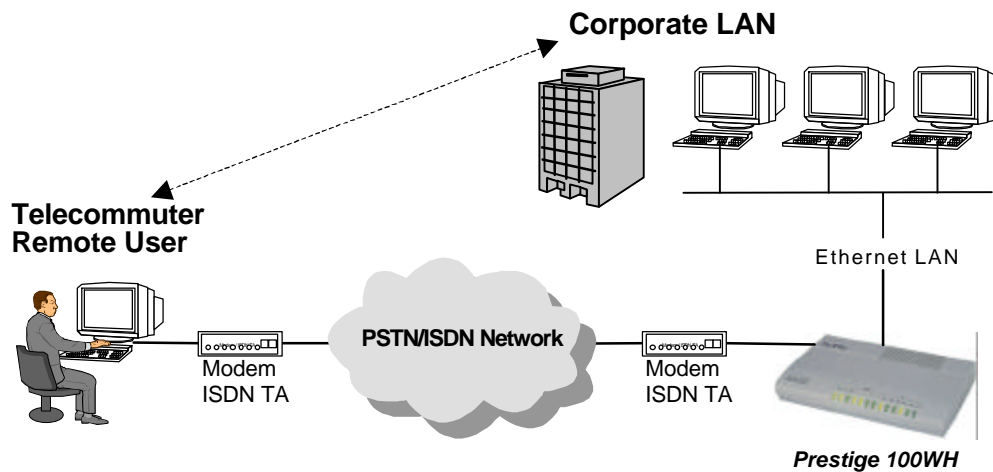

Figure 6-1. Example of Remote User: Telecommuter

6.2 LAN-to-LAN Application

Your *Prestige* can also be used as a LAN-to-LAN server. This application allows your *Prestige* to connect two geographically separate LANs. For your *Prestige* to be set up as a LAN-to-LAN server, you need to configure the Default Dial-In Setup to set the operational parameters for incoming calls. Additionally, you will have to create a remote node for the router on the remote network (See *Chapter 5 - Remote Node Configuration*).

An example of your *Prestige* being used as a LAN-to-LAN server is shown in Figure 6-2.

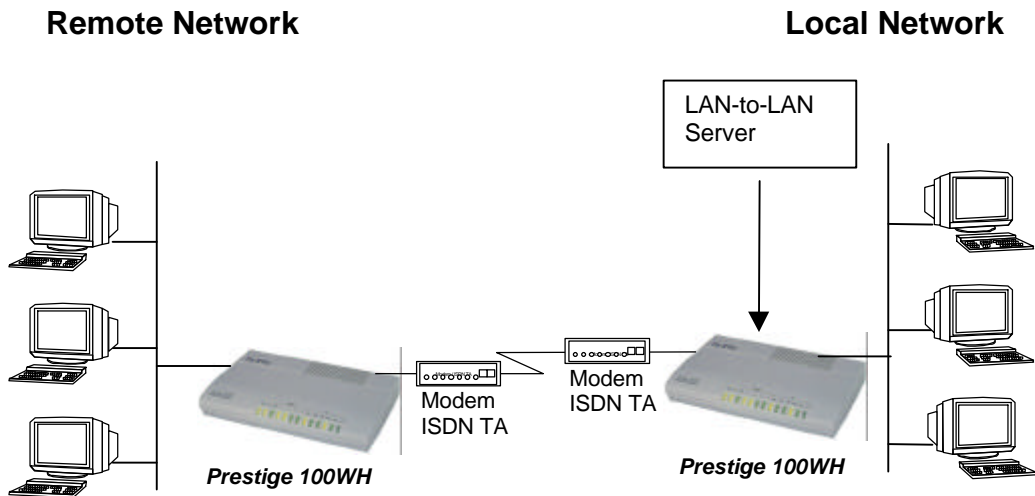

Figure 6-2. Example of a LAN-to-LAN Application

6.3 Default Dial-In Setup

This section covers the default dial-in parameters. The parameters in Menu 13 affect incoming calls from all remote dial-in users and remote nodes until authentication is completed. Once authentication is completed, and if it matches a remote node, your *Prestige* will use parameters from that particular remote node.

```
Menu 13 - Default Dial-in Setup

Telco Options:                               IP Address Supplied By:
  CLID Authen= None                          Dial-in User= Yes
                                              IP Pool= No
                                              IP Start Addr= N/A

PPP Options:
  Recv Authen= CHAP/PAP                     Session Options:
  Compression= Yes                          Input Filter Sets=
  Mutual Authen= No                          Output Filter Sets=
  PAP Login= N/A                             Idle Timeout= 300
  PAP Password= N/A

Callback Budget Management:
  Allocated Budget(min)=
  Period(hr)=

Press ENTER to CONFIRM or ESC to CANCEL:

Press Space Bar to Toggle.
```

Figure 6-3. Menu 13 - Default Dial-in Setup

From the Main Menu, enter 13 to go to Menu 13 - Default Dial-in Setup. This section will describe how to configure the protocol-independent fields in this menu. For the protocol-dependent fields, refer to the appropriate chapters.

Table 6-2 describes and contains information on how to configure each parameter in Menu 13 - Default Dial-in Setup.

Table 6-2. Default Dial-in Setup Fields

Field	Description
Telco Options: CLID Authen	<p>This field sets the CLID (Calling Line ID) authentication parameter for all incoming calls. There are three options for this field:</p> <ul style="list-style-type: none"> ● None - No CLID is required. ● Required – CLID MUST be available, or the <i>Prestige</i> will not answer the call. ● Preferred - If the CLID is available then CLID will be used for authentication. If the CLID is not available, authentication is done in PPP negotiation.
PPP Options: Recv. Authen	<p>This field sets the authentication protocol used for incoming calls. User names and passwords are configured in the next section (Dial-in Users Setup). Options for this field are:</p> <ul style="list-style-type: none"> ● CHAP/PAP - Your <i>Prestige</i> will try CHAP first, but PAP will be used if CHAP is not available. ● CHAP - Use CHAP only. ● PAP - Use PAP only. ● None - Your <i>Prestige</i> will try CHAP first, but no authentication is required if CHAP is not available.
PPP Options: Mutual Authen	<p>Some vendors (for example, Cisco) implement mutual authentication. That is, the node that initiates the call will request a user name and password from the far end that they are dialing to. If the remote node that is dialing in implements this type of authentication, set this field to Yes.</p>
PAP Login	<p>This field will only be enabled if the Mutual Authen. Field is [Yes]. Enter in the PAP login name for this <i>Prestige</i>. This field does not apply to CHAP authentication.</p>
PAP Password	<p>This field will only be enabled if the Mutual Authen is [Yes]. Enter the PAP password for this <i>Prestige</i>. This field does not apply to CHAP authentication.</p>

Table 6-2. Default Dial-in Setup Fields (continued)

Field	Description
Callback Budget Management: Allocated Budget (min)	This field sets the budget callback time for all the dial-in users. The default for this field is [0] for unlimited budget.
Callback Budget Management: Period (hr)	This field sets the time interval to reset the above callback budget control.
Dial-In IP Address Supplied By: Dial-in User	If set to [Yes], it tells your <i>Prestige</i> to allow a remote host to specify its own IP address. If set to [No], the remote host must use the IP address assigned by your <i>Prestige</i> from the IP pool, configured below. This is to prevent the remote host from using an invalid IP address and potentially disrupting the whole network.
Dial-In IP Address Supplied By: IP Pool	This field tells your <i>Prestige</i> to provide the remote host with an IP address from the pool. This field is required if Dial-In IP Address Supplied By: Dial-in User is set to [No]. You can configure this field even if Dial-in User is set to [Yes], in which case your <i>Prestige</i> will accept the IP address if the remote peer specifies one; otherwise, an IP address is assigned from the pool.
IP Pool: IP Start Addr	This field is active only if you selected [Yes] in the Dial-In IP Address Supplied By: IP Pool field. The IP pool contains contiguous IP addresses and this field specifies the first one in the pool.

Table 6-2. Default Dial-in Setup Fields (continued)

Field	Description
Session Options: Input Filter Sets Output Filter Sets	<p>In these fields, select the filter set(s) to apply to the incoming and outgoing traffic between your <i>Prestige</i> and the dial-in user. Keep in mind that the filter set(s) will only apply to all dial-in users but not the remote nodes.</p> <p>You can choose from 12 different filter sets. In addition, you can link up to 4 filter sets together for further customization (for example, 1, 5, 9, 12).</p> <p>Note that spaces and [-] symbol, are accepted in this field. For more information on customizing your filter sets, see <i>Chapter 7 – Filter Configuration</i>. The default is blank, i.e., no filters.</p>
Session Options: Idle Timeout	<p>The Idle Timeout sets the limit on the time that the connection is idle before the dial-in user is automatically disconnected. The idle timer is reset whenever there is traffic from the <i>Prestige</i>.</p> <p>This field will be used when the <i>Prestige</i> calls back to a dial-in user.</p>
<p>Once you have completed filling in Menu 13 - Default Dial-in Setup, press [Enter] at the message [Press ENTER to Confirm...] to save your configuration, or press [Esc] at any time to cancel.</p>	

6.4 Dial-In Users Setup

The following steps describe the setup procedure for adding a dial-in user.

- Step 1.** From the Main Menu, enter option 14 to go to Menu 14 - Dial-in User Setup, as shown in Figure 6-4.

```
Menu 14 - Dial-in User Setup

1. johndoe
2. _____
3. _____
4. _____
5. _____
6. _____
7. _____
8. _____

Enter Menu Selection Number:
```

Figure 6-4. Menu 14 - Dial-in User Setup

- Step 2.** Select one of eight users by number, this will bring you to Menu 14.1 - Edit Dial-in User, as shown in Figure 6-5.

```
Menu 14.1 - Edit Dial-in User

User Name= ?
Active= Yes
Password= ?
Callback= No
  Phone # Supplied by Caller= N/A
  Callback Phone #= N/A
Rem CLID=
Idle Timeout= 300

Press ENTER to Confirm or ESC to Cancel:
```

Figure 6-5. Menu 14.1 - Edit Dial-in User

Table 6-3 provides instructions on how to fill in the Edit Dial-In User fields.

Table 6-3. Edit Dial-in User Menu Fields

Field	Description
User Name	This is a required field. This will be used as the login name for authentication. Choose a descriptive word for login, for example, [johndoe].
Active	You can disallow dial-in access to this user by setting this field to [Inactive]. Deactivated users are displayed with a [-] (minus sign) at the beginning of the name in Menu 14.
Password	Enter the password for this dial-in user.
Callback	<p>This field determines if your <i>Prestige</i> will allow call back to the user upon dial-in. If this option is enabled, your <i>Prestige</i> will call back to the dial-in user if they request it. In such a case, your <i>Prestige</i> will disconnect the initial call from this user and dial back to the specified callback number (see below).</p> <ul style="list-style-type: none"> ● [No] - The default is [no callback]. ● [Optional] - The user can choose to disable callback. ● [Mandatory] - The user can not disable callback.
Phone # Supplied by Caller	<p>This option allows the Remote Dial-in User to specify the call back telephone number on a call-by-call basis. This is useful when your <i>Prestige</i> returns a call back to a mobile user at different numbers (for example, a Sales Rep. in a hotel).</p> <ul style="list-style-type: none"> ● If the setting is [Yes], the user must send the callback number of his/her choice to the <i>Prestige</i> in PPP negotiation. ● Note that the default is [No], i.e., your <i>Prestige</i> always calls back to the fixed callback number specified in the next field.
Callback Phone #	If [Phone # Supplied by Caller] is [No], then you must enter the telephone number to which your <i>Prestige</i> will call back. Otherwise, a [N/A] will appear in the field.

Table 6-3. Edit Dial-in User Menu Fields (continued)

Field	Description
Rem CLID	If you have enabled the CLID Authen field in Menu 13, then you need to specify the telephone number from which this dial-in user calls. Your <i>Prestige</i> will check this number against the CLID in the incoming call. If they do not match and the CLID Authen is Required, then your <i>Prestige</i> will not answer the call.
Idle Time-out	Enter the idle time (in seconds). This time-out determines how long the dial-in user can be idle before your <i>Prestige</i> disconnects the call. Idle time is defined as the period of time where there is no data traffic between the dial-in user and your <i>Prestige</i> . The default is 300 seconds (5 minutes).
Once you have completed filling in Menu 14.1 - Edit Dial-in User, press [Enter] at the message [Press ENTER to Confirm...], to save your configuration, or press [Esc] at any time to cancel	

6.5 CLID Authentication

CLID (Calling Line ID) authentication affords you the security of limiting a user to only initiate connections from a fixed location. The *Prestige* uses the caller ID sent by the switch to match against the CLIDs in the database. Please note that for CLID authentication to work on the *Prestige*, your telephone company must support caller ID. You must also include the AT command that enables call ID detection on your modem in Menu 2.1.

6.6 Callback

Callback serves two purposes. One is security. When set to callback to a fixed number, an intruder will not gain access to your network even if he/she stole the password from your user, because the *Prestige* always calls back to the pre-configured number.

The other is ease of accounting. For instance, your company pays for the connection charges for telecommuting employees and you use your *Prestige* as the dial in server. When you turn on the callback option for the dial-in users, all usage are charged to the company instead of the employees, and your accounting department can avoid the hassles of accountability and reimbursement.

Chapter 7

Filter Configuration

About Filtering

Your *Prestige* uses filters to decide whether or not to allow passage of a data packet and/or to make a call over the Modem line. There are three types of filters involved:

- Incoming Data Filters
- Outgoing Data Filters
- Call Filters.

Data filters screen the data to determine if the packet should be allowed to pass. Call filters are used to determine if a call should be placed.

Outgoing packets must pass through the data filters before they encounter the call filters. Call filters are divided into two groups

- Built-in Call Filters
- User-defined Call Filters.

Your *Prestige* has built-in call filters that filter out administrative, e.g., RIP, packets. These built-in filters are always enabled and not accessible to the user. Your *Prestige* applies the built-in filters first and then the user-defined call filters if applicable, as illustrates in Figure 7-1, outgoing packet filtering process

The *Prestige* has a default call filter “NetBEUI_WAN” configured and enabled in your ISP remote node that prevents Windows NetBEUI packets from triggering calls. If you need to disable this filter, go to Menu 11 and delete it from the call filter sets. You can also add this default call filter to another remote node by including it in the remote node’s call filter sets.

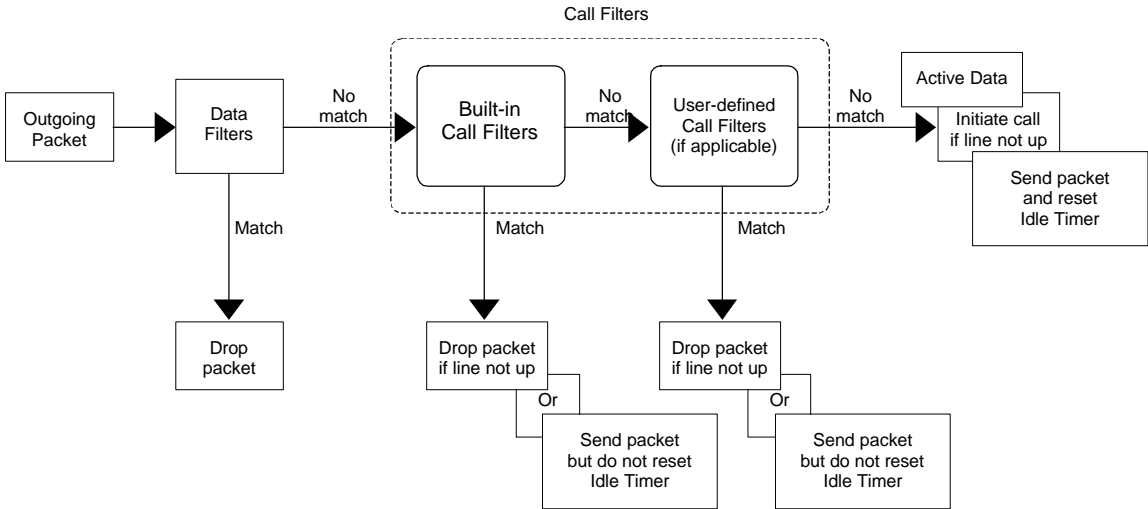

Figure 7-1. Outgoing Packet Filtering Process

For incoming packets, your *Prestige* applies data filters only. Packets are processed depending upon whether a match is found. Your *Prestige* allows you to customize the filter sets that you wish to use. The following sections describe how to configure filter sets.

The Filter Structure of the *Prestige*

You can configure up to twelve filter sets with six rules in each set, allowing you to customize up to 72 filter rules (12 x 6).

When implementing these filter sets, you can link up to four of the filter sets together to screen the data packet. Therefore, with each filter set having up to six rules, you can have a maximum of 24 rules active for a single filtering application.

7.1 Configuring a Filter Set

In order to distinguish between the 12 filter sets, each filter set should have a name or some sort of Comments. You can edit these Comments in the following way:

- Step 1.** From the Main Menu, select option [21. Filter Set Configuration].
- Step 2.** When Menu 21 - Filter Set Configuration appears, you can choose among 12 filter sets. Select the filter set you wish to configure (no. 1-12), then press [Enter].
- Step 3.** This will bring you to the Edit Comments field. Whatever the comments are for that filter set will be displayed in this field. You can edit the comments you wish to use to identify that filter set.

Once you have completed filling in Edit Comments field, press [Enter] at the message: [Press ENTER to confirm] to save the configuration, or press [Esc] at any time to cancel.

The new information will now be displayed in the read-only section of Menu 21 - Filter Set Configuration as shown in Figure 7-2.

```

                                Menu 21 - Filter Set Configuration

Filter                               Filter
Set #                               Set #
-----                               -----
1                                   7
2                                   8
3                                   9
4                                   10
5                                   11
6                                   12

                                Enter Filter Set Number to Configure=
                                Edit Comments=
                                Press ENTER to CONFIRM or ESC to CANCEL:

```

Figure 7-2. Menu 21 - Filter Set Configuration

Step 4. Once you press [Enter] to confirm your changes, Menu 21.1 - Filter Rules Summary appears.

7.1.1 Filter Rules Summary Menu

The information displayed in the Menu 21.1 - Filter Rules Summary is read-only. From here, you can examine the parameters of each rule that you have configured for that filter set.

Figure 7-3 displays Menu 21.1 - Filter Rules Summary.

```

Menu 21.1 - Filter Rules Summary
# A Type                Filter Rules                M m n
-----
1 N
2 N
3 N
4 N
5 N
6 N

Enter Filter Rule Number (1-6) to Configure:
    
```

Figure 7-3. Menu 21.1 - Filter Rules Summary

The following Table 7-1 contains a brief description of the abbreviations used in Menu 21.1.

Table 7-1. Abbreviations Used in the Filter Rules Summary Menu

Abbreviations	Description
#	Refers to the filter rule number (1-6).
A	Refers to Active. [Y] means the filter rule is active. [N] means the filter rule is inactive.
Type	Refers to the type of filter rule. This can display GEN for generic, or IP for TCP/IP.

Table 7-1. Abbreviations Used in the Filter Rules Summary Menu (continued)

Abbreviations	Description
Filter Rules	The filter rule parameters will be displayed here (see below).
M	Refers to More. [Y] means there are more rules to check. [N] means there aren't more rules to check.
m	Refers to Action Matched. [F] means to forward the packet. [D] means to drop the packet. [N] means check the next rule.
n	Refers to Action Not Matched [F] means to forward the packet. [D] means to drop the packet. [N] means check the next rule.

The protocol dependent filter rules abbreviation are listed as follows:

- If the filter type is IP (TCP/IP), the following abbreviations listed in Table 7-2 will be used.

Table 7-2. Abbreviations Used If Filter Type Is IP

Abbreviation	Description
Pr	Protocol
SA	Source Address
SP	Source Port number
DA	Destination Address
DP	Destination Port number

- If the filter type is GEN (generic), the following abbreviations listed in Table 7-3 will be used.

Table 7-3. Abbreviations Used If Filter Type Is GEN

Abbreviation	Description
Off	Offset
Len	Length

For more information on configuring the filter rule parameters, refer to the next section.

To configure a specific filter rule, simply select the number of the filter rule (1-6) you wish to configure and press [Enter]. This will take you to Menu 21.1.1 - TCP/IP Filter Rule in next section.

7.2 Configuring a Filter Rule

There are four types of filter rules that you can configure. Some of the parameters will differ depending on the type of rule. When you first enter the Filter Rule Menu, you will be presented with Menu 21.1.1 - TCP/IP Filter Rule. If you wish to configure another type of filter rule, you need to select the appropriate type (by pressing SPACE bar) under the Filter Type field and press [Enter]. This will bring you to the corresponding menu.

7.2.1 TCP/IP Filter Rule

This section will show you how to configure a TCP/IP filter rule for your *Prestige*.

Figure 7-4 displays Menu 21.1.1 TCP/IP Filter Rule.

```
Menu 21.1.1 - TCP/IP Filter Rule
Filter #: 1,1
Filter Type= TCP/IP Filter Rule
Active= No
IP Protocol= 0      IP Source Route= No
Destination: IP Addr=
               IP Mask=
               Port #= 0
               Port # Comp= None
Source: IP Addr=
         IP Mask=
         Port #= 0
         Port # Comp= None
TCP Estab= N/A
More= No      Log= None
Action Matched= Check Next Rule
Action Not Matched= Check Next Rule

Press ENTER to Confirm or ESC to Cancel:
Press Space Bar to Toggle.
```

Figure 7-4. Menu 21.1.1 - TCP/IP Filter Rule

The following Table 7-4 describes how to configure your TCP/IP filter rule.

Table 7-4. TCP/IP Filter Rule Menu Fields

Field	Description
Active	Active and deactivate this filter rule.
IP Protocol	Specify the upper layer protocol number. The range for this value should be between 0 and 255. For example, TCP is 6 and UDP is 17.
IP Source Route	Determine whether to check the source route.
Destination: IP Addr	Enter the destination IP Address of the packet you wish to filter. The address is usually written in dotted decimal notation such as a.b.c.d where a, b, c, and d are numbers between 0 and 255.
Destination: IP Mask	Enter the IP mask that will be used to mask the bits of the IP Address given in Destination: IP Addr.
Destination: Port #	Enter the destination port of the packets that you wish to filter. The range of this field is 0 to 65535.
Destination: Port # Comp	Select the comparison you wish to apply to the value given in Destination: Port #.
Source: IP Addr	Enter the source IP Address of the packet you wish to filter.
Source: IP Mask	Enter the mask that will be used to mask the bits of the IP Address given in Source: IP Addr.
Source: Port #	Enter the source port of the packets that you wish to filter. The range of this field is 0 to 65535.
Source: Port # Comp	Select the comparison you wish to apply to the value given in Source: Port #.
TCP Estab	This field is applicable for TCP only and will be inactive (N/A) if it is IP protocol field is not 6. In this field you specify when to apply the filter. There are two options: [Yes] – filter match only established TCP connections. [No] – filter match any TCP packets.

Table 7-4. TCP/IP Filter Rule Menu Fields (continued)

Field	Description
More	<p>Specify if you want to pass the packet to the next filter rule before an action is taken.</p> <p>If More is [Yes], then Action Matched and Action Not Matched will be N/A.</p>
Log	<p>Determine if you wish to log the results of the filter rule. These results will be displayed on the System Log.</p> <p>There are 4 options for this field:</p> <ul style="list-style-type: none"> ● None - No packets will be logged. ● Action Matched - Only packets that match the rule parameters will be logged. ● Action Not Matched - Only packets that do not match the rule parameters will be logged. ● Both - All packets will be logged.
Action Matched	<p>Specify what to do with the packet if the conditions for the filter rule are matched. The choices are Check Next Rule, Forward the packet or Drop the packet.</p>
Action Not Matched	<p>Specify what to do with the packet if the conditions for the filter rule are not matched. The choices are Check Next Rule, Forward the packet or Drop the packet.</p>
<p>Once you have completed filling in Menu 21.1.1 - TCP/IP Filter Rule, press [Enter] at the message [Press ENTER to Confirm...] to save your configuration, or press [Esc] to cancel. This data will now be displayed on Menu 21.1 - Filter Rules Summary.</p>	

7.2.2 Generic Filter Rule

This section will show you how to configure the protocol-independent parameters for a Generic filter rule for your *Prestige*. (For information on the protocol-dependent fields, refer to the previous section, TCP/IP Filter Rule.)

Figure 7-5 displays Menu 21.1.2 - Generic Filter Rule

```
Menu 21.1.2 - Generic Filter Rule

Filter #: 1,1
Filter Type= Generic Filter Rule
Active= No
Offset= 0
Length= 0
Mask= N/A
Value= N/A
More= No           Log= None
Action Matched= Check Next Rule
Action Not Matched= Check Next Rule

Press ENTER to Confirm or ESC to Cancel:
Press Space Bar to Toggle.
```

Figure 7-5. Menu 21.1.2 - Generic Filter Rule

Table 7-5 describes the fields in the Generic Filter Rule Menu.

Table 7-5. Generic Filter Rule Menu Fields

Field	Description
Offset	Offset refers to the starting point from which you want to begin the comparison. The first byte has offset of 0. The range for this field is from 0 to 255.
Length	This field refers to the length (in bytes) of data in the packet that your <i>Prestige</i> should use for comparison and masking. The range for this field is 0 to 8.
Mask	In this field, specify (in Hexadecimal) the value that your <i>Prestige</i> should logically qualify [and] the data in the packet. Remember that each byte is represented by 2 hexadecimal digits. For example, hex FF is decimal 255.
Value	In this field, specify (in Hexadecimal) the value that your <i>Prestige</i> should use to compare with the masked packet. If the result from the masked packet matches Value, then the packet is considered matched.
Once you have completed filling in Menu 21.1.2 - generic Filter Rule, press [Enter] at the message [Press ENTER to Confirm] to save your configuration, or press [Esc] to cancel. This data will now be displayed on Menu 21.1 - Filter Rules Summary.	

Chapter 8

System Password

You must enter the correct password before the *Prestige* will allow you to access the configuration. The default password is 1234. As a security measure, you have three attempts to enter the correct password; after that, you will have to wait a predetermined period before the *Prestige* will allow you to try again.

To prevent one user from overriding another, your *Prestige* will only allow one user to login at one time.

8.1 Configure the System Password

The following steps describe a simple setup procedure for changing the password.

- Step 1.** From the Main Menu, select option [23. System Password]
- Step 2.** In Menu 23 - System Password, type in your existing system password and press [Enter].
- Step 3.** Type in your new system password and press [Enter].
- Step 4.** Re-type your new system password for confirmation purposes and press [Enter].

Chapter 9

Telnet Configuration and Capabilities

9.1 About Telnet Configuration

When you first configure your *Prestige*, it must be done via the console port since your *Prestige* does not have the network parameters set yet. However, once your *Prestige* has been configured, you can telnet to the *Prestige* remotely to perform the configuration, as shown in Figure 9-1.

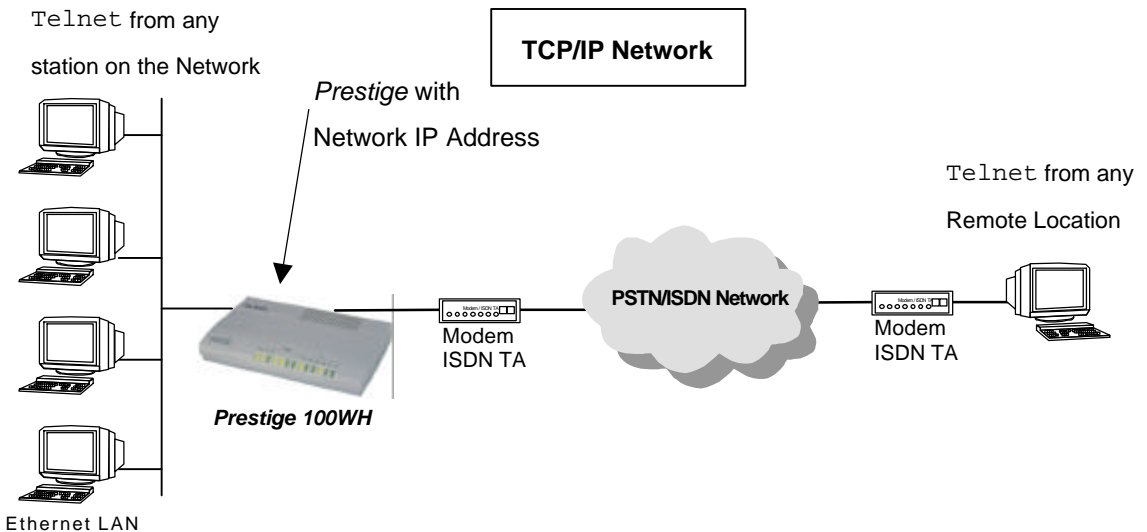

Figure 9-1. Telnet Configuration on a TCP/IP Network

9.2 Single Administrator

To prevent confusion and discrepancy on the configuration, your *Prestige* will only allow one user to login at any time. Your *Prestige* also gives priority to the console port over telnet. If you have already connected to your *Prestige* via telnet, you will be logged out if another user is connecting to the *Prestige* via the console port.

9.2.1 System Timeout

There is a system timeout of 5 minutes (300 seconds) for either the console port or telnet. Your *Prestige* will automatically log you out if there is no activity during this timeout period.

Chapter 10

System Maintenance

Your *Prestige* provides diagnostic tools that you can use to maintain your device. These tools include updates on system status, modem status, log and trace capabilities and upgrades to the system software. This chapter will describe how to use these tools in greater detail.

System maintenance options are available in Menu 24 - System Maintenance, as shown in Figure 10-1.

```
Menu 24 - System Maintenance

1. System Status
2. Terminal Baud Rate
3. Log and Trace
4. Diagnostic
5. Backup Configuration
6. Restore Configuration
7. Software Update
8. Command Interpreter Mode
9. Call Control

Enter Menu Selection Number:
```

Figure 10-1. Menu 24 - System Maintenance

10.1 System Status

System Status is a tool to monitor your *Prestige*. Specifically, it gives you information on the status of your system software version, modem, and number of packets sent and received, as shown in Figure 10-2.

```
Menu 24.1 -- System Maintenance - Status
Port  Status  Speed  TXPkts  RXPkts  Errs  TxB/s  RxB/s  Up Time
 1    Idle    0Kbps    0       0       0     0      0     0:00:00

Total Outcall Time:      0:00:00

Ethernet:
  Status: 10M/Full Duplex      Name: p100MH
  TX Pkts: 26                  RAS S/W Version: V2.11(I.01)b11 | 5/21/98
  RX Pkts: 0                   Ethernet Address: 00:a0:c5:00:10:32
  Collisions: 0

LAN Packet Which Triggered Last Call:

Press Command:

CMDS: 1-Drop Port1  2-Drop Port2  3-Drop Port3  8-Drop All  9-Rst Cnt  ESC-Exit
```

Figure 10-2. Menu 24.1 - System Maintenance - Status

Follow the procedure below to go to the System Status Menu.

- Step 1.** Select option 24 from the Main Menu to access Menu 24 - System Maintenance.
- Step 2.** From Menu 24, select option [1. System Status].
- Step 3.** There are 3 possible commands in Menu 24.1 - System Maintenance - Status.
 - Entering 1 will disconnect the current call;
 - Entering 9 will reset the counters;
 - and [Esc] will exit this screen.

The following Table 10-1 describes the fields present in Menu 24.1 - System Maintenance - Status.

It should be noted that items 1-17 in this Table 10-1 are READ-ONLY and are meant to be used for diagnostic purposes.

Table 10-1. System Maintenance - Status Menu Fields

Field	Description
1. Port	Shows statistics for the WAN port.
2. Status	Shows the remote node that is currently connected to or the status of the port ([Idle], [Calling], or [Answering]).
3. Speed	The current connecting speed.
4. TXPkts	The accumulated number of transmitted packets.
5. RXPkts	The accumulated number of received packets.
6. Errs	The number of error packets.
7. Tx B/s	The running display of the number of bytes transmitted in the last second.
8. Rx B/s	The running display of the number of bytes received in the last second.
9. Up Time	Time this call has been up.
10. Total Outgoing call Time	Shows the total outgoing call time for the WAN port since the system was powered up.
11. Ethernet	Shows the current status of the LAN connection on your <i>Prestige</i> .
12. Status	Shows the current status of the LAN.
13. TX Pkts	The number of transmitted packets to LAN.
14. RX Pkts	The number of received packets from LAN.

Table 10-1. System Maintenance - Status Menu Fields (continued)

Field	Description
15. Collision	Number of collisions (more than one station try to transmit at the same time) on the Ethernet..
16. Name	Displays the system name of your <i>Prestige</i> . This information can be modified in Menu 1 - General Setup.
17. RAS S/W Version	The version number of the current RAS software.
18. Ethernet Address	Refers to the Ethernet MAC address assigned to your <i>Prestige</i> .
19. LAN Packet Which Triggered Last Call	Shows the first 48 octets of the LAN packet that triggered the last outgoing call. By viewing the packet information, you can determine which station has sent a packet to cause your <i>Prestige</i> to make an outgoing call.

Figure 10-3 shows two examples of LAN packets that trigger the call: the first an ICMP echo (ping) packet and the second a DNS query. With this information, you can determine the source station that triggers the call and what the application is doing.

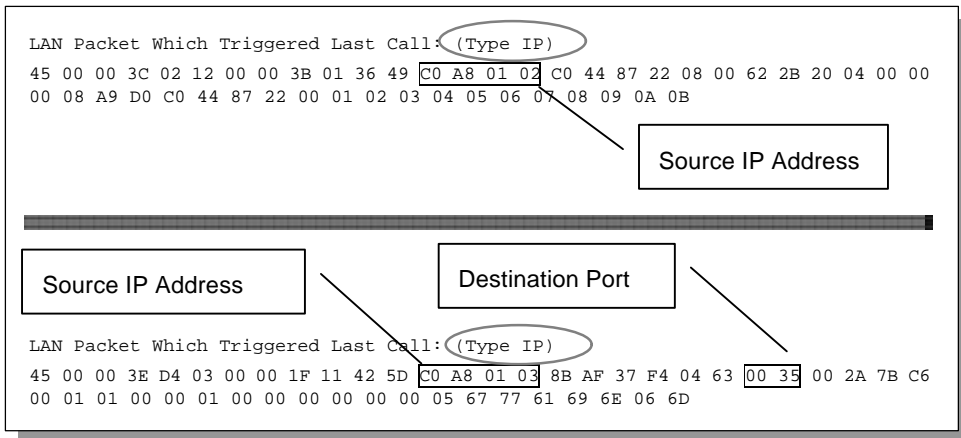
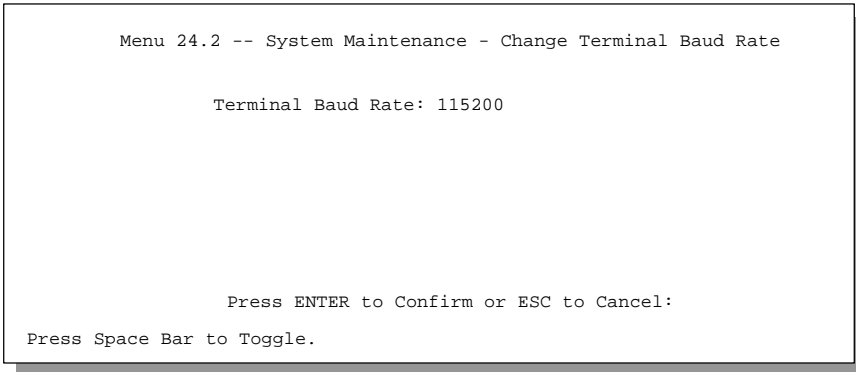

Figure 10-3. LAN Packet Which Triggered Last Call

10.2 Terminal Baud Rate

You can set up different baud rates for the console port through Menu 24.2 - Terminal Baud Rate. Your *Prestige* supports 9600 (default), 19200, 38400, and 115200bps for the console port. The terminal baud rate is displayed in Menu 24.2, as shown in Figure 10-4.

A screenshot of a terminal window showing the configuration menu for the terminal baud rate. The text is as follows:

```
Menu 24.2 -- System Maintenance - Change Terminal Baud Rate

Terminal Baud Rate: 115200

Press ENTER to Confirm or ESC to Cancel:
Press Space Bar to Toggle.
```

Figure 10-4. Menu 24.2 - System Maintenance - Change Terminal Baud Rate

10.3 Log and Trace

Log and trace tools allow you to view the error logs and trace records to troubleshoot any errors that may occur. The *Prestige* is also able to generate syslogs to send to other machines.

Follow the procedure below to get to the Log and Trace:

- Step 1.** Select option 24 from the Main Menu to access Menu 24 - System Maintenance.
- Step 2.** From Menu 24, select option 3 to bring you to Menu 24.3 - System Maintenance - Log and Trace.

Step 3. You will be given two options:

1. View Error Log.
2. Syslog and Accounting.

The following sections describe the fields involved in the trace and log options.

10.3.1 View Error Log

Selecting the first option from Menu 24.3 - System Maintenance - Log and Trace will display the Error Log in the system. The Error Log not only provides the error messages but also is a source of information about your *Prestige*.

You can also clear the Error Log on your *Prestige*. After each display, you are prompted with an option to do so. Enter the appropriate choice and press [Enter].

Examples of typical Error and Information Messages are presented in Figure 10-5.

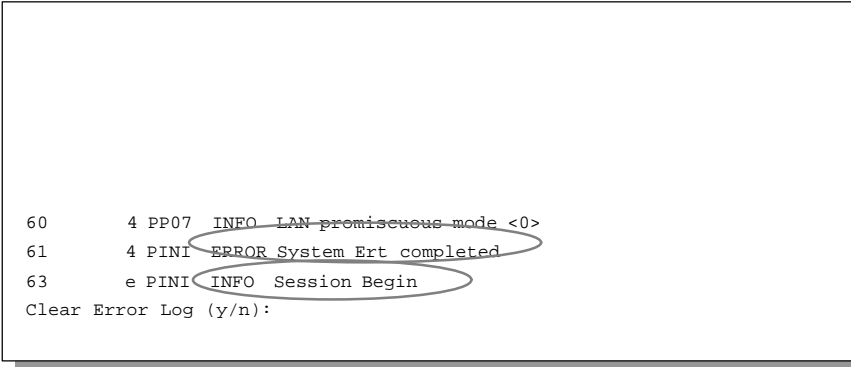

```
60      4 PP07 INFO LAN promiscuous mode <0>
61      4 PINI ERROR System Ert completed
63      e PINI INFO Session Begin
Clear Error Log (y/n):
```

Figure 10-5. Examples of Error and Information Messages

10.3.2 Syslog And Accounting

The *Prestige* uses the UNIX syslog facility to log the CDR (Call Detail Record) and system messages to a syslog server. Syslog and Accounting can be configured in Menu 24.3.2 - System Maintenance - Syslog and Accounting, as shown in Figure 10-6.

```

Menu 24.3.2 -- System Maintenance - Syslog and Accounting

Syslog:
Active= No
Syslog IP Address= ?
Log Facility= Local 1

Press ENTER to Confirm or ESC to Cancel:

Press Space Bar to Toggle.

```

Figure 10-6. Menu 24.3.2 - System Maintenance - Syslog and Accounting

You need to configure the following 3 parameters described in Table 10-2 to activate syslog.

Table 10-2. System Maintenance Menu Syslog Parameters

Parameter	Description
Active	Use the space bar to turn on or off the syslog option
Syslog IP Address	Enter the IP Address of the syslog server.
Log Facility	Use the space bar to toggle between the 7 different Local options. The log facility allows you to log the message in different files in the server. Please refer to your UNIX manual for more detail.

Your *Prestige* sends three different types of syslog messages: Call information messages (i.e. CDR), Error information messages, and Session information messages. Some examples of these syslog messages are shown below:

Call Information Messages:

```
line 1 channel 1, call 41, C01, Incoming Call, 40001  
line 1 channel 1, call 41, C01, ANSWER Connected, 64K 40001  
line 1 channel 1, call 41, C01, Incoming Call, Call Terminated
```

Error Information Messages:

```
line 1, channel 1, call 44, E01, CLID call refuse  
line 1, channel 1, call 45, E02, IP address mismatch
```

Session Information Messages:

```
line 1, channel 1, call 41, I01, IPCP up, 306L  
line 1, channel 1, call 41, I01, IPCP down, 306L
```

10.4 Diagnostic

The diagnostic functions allow you to test aspects of your *Prestige* to determine if it is working properly. Menu 24.4 allows you to choose among various types of diagnostic tests to evaluate your system, as shown in Figure 10-7.

```
Menu 24.4 - System Maintenance - Diagnostic

WAN
  1. Drop WAN Port
  2. Reset WAN Port
  3. Manual Call1
  4. Redirect to WAN Port

TCP/IP
  11. Internet Setup Test
  12. Ping Host

System
  21. Reboot System
  22. Command Mode

Enter Menu Selection Number:

Manual Call Remote Node= N/A
Host IP Address= N/A
```

Figure 10-7. Menu 24.4 - System Maintenance - Diagnostic

Follow the procedure below to get to Diagnostic

- Step 1.** From the Main Menu, select option 24 to access Menu 24 - System Maintenance.
- Step 2.** From this menu, select option 4. Diagnostic. This will bring you to Menu 24.4 - System Maintenance - Diagnostic.

The following Table describes the eight diagnostic test options available in Menu 24.4.

Table 10-3. System Maintenance Menu Diagnostic Test Options

Fields	Description
Drop WAN Port	This command will drop the current call.
Reset WAN Port	This command will reset the WAN Port.
Redirect to WAN Port	This command will redirect the keyboard to the WAN Port. Anything you type will be sent to the WAN device and the device's response will be shown on your terminal.
Internet Setup Test	This test checks to see if your Internet access configuration is correct. When this option is chosen, your <i>Prestige</i> will call the ISP and perform the PPP negotiations. If everything is working properly, you will receive an appropriate response. Otherwise, note the error message and consult your network administrator.
Ping Host	This diagnostic sends an ICMP echo packet to the remote host and shows you the round-trip time when the <i>Prestige</i> gets a response. This is to test if the host is reachable via TCP/IP.
Reboot System	This option reboots the system.
Command Mode	This option allows you to enter the command mode. This mode allows you to diagnose and test your <i>Prestige</i> using a specified set of commands.
Manual Call	This option allows you to manually place a call to a remote node. The <i>Prestige</i> will show you traces of what is happening during the call setup and PPP negotiation.

Figure 10-8 displays an example of a successful connection after selecting option [3. Manual Call] in Menu 24.4.

```
Start dialing for node <1>
### Hit any key to continue. ###
Dialing chan<2> phone<last 9-digit>:40101
Call CONNECT speed<64000> chan<2> prot<1>
LCP up
CHAP send response
CHAP login to remote OK!
IPCP negotiation started
IPCP up
```

Figure 10-8 Successful connection after selecting option [3. Manual Call] in Menu 24.4.

Figure 10-9 shows a trace example where authentication failed.

```
Strat dialing for node <1>
### Hit any key to continue. ###
Dialing chan<2> phone<last 9-digit>:40101
Call CONNECT speed<64000> chan<2> prot<1>
LCP up
CHAP send response
***Login to remote failed. Check name/passwd.
Receive Terminal REQ
IPCP down
Line Down chan<2>
```

10.5 Backup Configuration

Option 5 from Menu 24 - System Maintenance allows you to backup the current *Prestige* configuration to your workstation. Backup is highly recommended once your *Prestige* configuration is functioning.

You must perform the backup and restore through the console port. Any serial communications program should work fine; however, you must use XMODEM protocol to perform the download/upload.

Please note that terms “download” and “upload” are relative to the workstation. Download means to transfer from another machine to the workstation, while upload means from your workstation to another machine.

10.6 Restore Configuration

Selecting option 6 from Menu 24 - System Maintenance to restore the configuration from your workstation to the *Prestige*. Again, you must use the console port and XMODEM protocol to restore the configuration.

Keep in mind that the configuration is stored in the flash ROM in the *Prestige*, so even if power failure should occur, your configuration is safe.

10.7 Firmware Update

Firmware updates are only possible through the console prt. Note that this function will erase the old code before installing the new firmware. Do not attempt to update unless you have the new firmware at hand. There are two different firmware updates: RAS code and ROM File, as shown in Menu 24.7 (Figure 10-10).

```
Menu 24.7 -- System Maintenance - Upload Firmware

1. Load RAS Code
2. Load ROM File

Enter Menu Selection Number:
```

Figure 10-10. Menu 24.7 - System Maintenance - Upload Firmware

10.7.1 Uploading Firmware

Menu 24.7.1 shows you the instructions for uploading RAS code (firmware). If you answer yes to the prompt, the *Prestige* will reboot automatically. Press any key when you see the message “Press Any key to enter Debug Mode within 3 seconds.” to enter debug mode.

Once in debug mode, type [atur] and wait for your *Prestige* to respond with “Starting XMODEM upload” to begin uploading the new firmware (upload procedure varies depending on the software used to access your *Prestige*). After successfully uploading the new firmware, type [atgo] to restart your *Prestige*.

```
Menu 24.7.1 -- System Maintenance - Upload RAS Code

To load the RAS code, type "atur" while in debug mode and wait for
"Starting XMODEM upload" before beginning to upload code.
Type "atgo" after code has successfully loaded to start RAS.

Proceeding with the upload will erase the current RAS code.

Do You Which To Proceed:(Y/N)
```

Figure 10-11. Menu 24.7.1 - Example of Uploading RAS Using PCPLUS

10.7.2 Uploading ROM File

Menu 24.7.2 shows you the instructions for uploading ROM file. Uploading the ROM file replaces the entire ROM file system, which includes the *Prestige*'s configuration, system-related data, the error log and the trace log. If you answer yes to the prompt, the *Prestige* will reboot automatically. Press any key when you see the message "Press Any key to enter Debug Mode within 3 seconds." to enter debug mode.

Once in debug mode, type [atur3] and wait for your *Prestige* to respond with "Starting XMODEM upload" to begin uploading the ROM file. (upload procedure varies depending on the software used to access your *Prestige*). After successfully uploading the ROM file, type [atgo] to restart your *Prestige*.

If you upload the default ROM file, you will lose all configurations that you had before and the console port will be set to the default of 9600 baud. You will need to change the baud rate of your serial communications software to 9600 before you can connect to the *Prestige* again.

```
Menu 24.7.2 -- System Maintenance - Upload ROM File

To load the ROM file, type "atur3" while in debug mode and wait for
"Starting XMODEM upload" before beginning to upload file. Type
"atgo" after file has successfully loaded to start RAS. Then change
the baud rate to 9600.

Proceeding with the upload will erase the current ROM file.

Do You Which To Proceed:(Y/N)
```

Figure 10-12. Menu 24.7.2 - System Maintenance - Upload ROM File

10.8 Command Interpreter Mode

This option allows you to enter the command interpreter mode. A list of valid commands can be found by typing [help] at the command prompt. For more detailed information, check the ZyXEL Web site or send an e-mail to the ZyXEL Support Group.

10.9 Call Control

The *Prestige* provides two Call Control Management functions: Budget Management and Blacklist.

The Budget Management function allows you to set a limit on the total outgoing call time of the *Prestige* over a period of time. When the total outgoing call time exceeds the limit, the current call will be dropped and any future outgoing calls will be blocked.

The Blacklist function prevents the *Prestige* from re-dialing to an unreachable phone number. It is a list of phone numbers, up to a maximum of 14, to which the *Prestige* will not make an outgoing call. If the *Prestige* tries to dial to a phone number and fails a certain number of times (configurable in Menu 24.9.1), then the phone number is put in the blacklist. You will have to enable the number manually before the *Prestige* will dial that number again.

To enter the Call Control menu, select option [9. Call Control] in Menu 24 to go to Menu 24.9 - System Maintenance - Call Control, as shown in Figure 10-15.

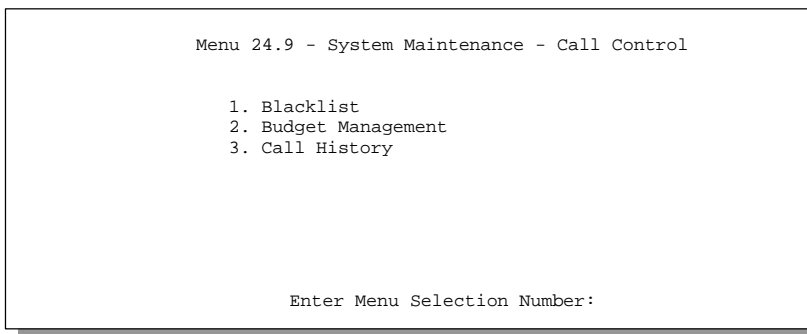

Figure 10-15. Menu 24.9 - System Maintenance - Call Control

10.9.1 Blacklist

Menu 24.9.2 shows a list of telephone numbers that have been blacklisted.

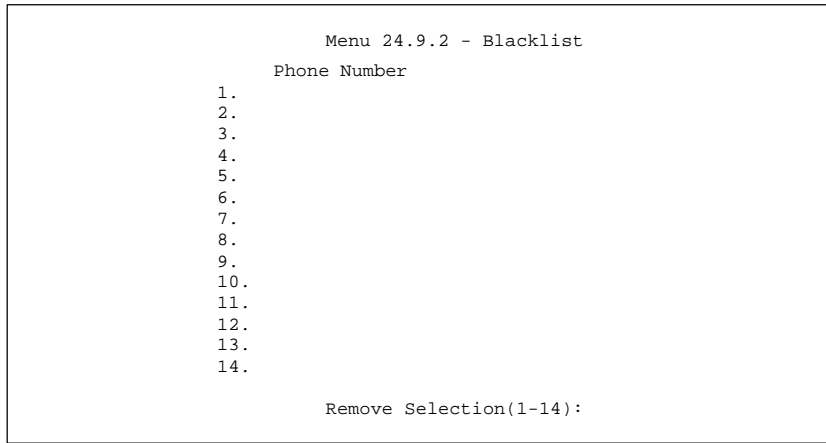

Figure 10-16. Menu 24.9.2 - Blacklist

The phone numbers on this list are numbers that have had problems connecting in the past and therefore cannot be manipulated by you. You can only take a number off the list by entering its index number.

10.9.2 Budget Management

Menu 24.9.3 shows the Budget Management statistics for outgoing calls.

Remote Node	Connection Time/Total Budget	Elapsed Time/Total Period
1. ispl	No Budget	No Budget
2. -----	---	---
3. -----	---	---
4. -----	---	---
5. Dial-in User	No Budget	No Budget

Reset Node (0 to update screen):

Figure 10-17. Menu 24.9.3 - Budget Management

The total budget is the time limit on the accumulated time for outgoing call to a remote node or for calling back to the dial-in users collectively. When this limit is reached, the call will be dropped and further outgoing calls to that remote node or dial-in user (callback) will be blocked. After each period, the total budget is reset. The default for the total budget is 0 minutes and the period is 0 hours, meaning no budget control. You can reset the accumulated connection time in this menu by entering the index of a remote node or the dial-in users. The budget and the reset period can be configured in the Menu 11 and 13 for a remote node and for the dial-in user, respectively.

Chapter 11

Troubleshooting

This chapter covers ways of dealing with potential problems you may run into when using your *Prestige*. After each problem description, some instructions are provided to help you to diagnose and to solve the problem.

11.1 Problems Starting Up the *Prestige*

Table 11-1. Troubleshooting the Start-Up of your *Prestige*

Troubleshooting	Corrective Action	
None of the LEDs are on when you power on the <i>Prestige</i>	<p>Check the power cord and the power supply and make sure it is properly connected to your <i>Prestige</i>.</p> <p>If the error persists you may have a hardware problem. In this case you should contact technical support.</p>	
You cannot access the <i>Prestige</i> via the console port.	1. Check to see if the <i>Prestige</i> is connected to your computer's serial port.	
	2. Check to see if the communications program is configured correctly. The communications software should be configured as follows:	VT100 terminal emulation
		9600 Baud rate.
No parity, 8 Data bits, 1 Stop bit.		

11.2 Problems With the Modem

Table 11-2. Troubleshooting a WAN Port Connection

Symptoms	Corrective Action
No modem/TA lights are on while placing a call	Check if the modem/TA is properly connected to the wall jack.

11.3 Problems with the LAN Interface

Table 11-3. Troubleshooting the LAN Interface

Symptoms	Corrective Action
Can't ping a station on the LAN	Check if the LAN LED on the front panel of your <i>Prestige</i> is on. If it is off, then check the cable connecting your <i>Prestige</i> to that station.
	Verify that the IP address and the subnet mask in Menu 3.2 are valid for that LAN.

11.4 Problems Connecting to a Remote node or ISP

Table 11-4. Troubleshooting a Connection to a Remote Node or ISP

Symptoms	Corrective Action
Can't Connect to a remote node or ISP	Check Menu 24.1 to verify the WAN port status. If it indicates [down], then refer to the section on the WAN port problems.
	In Menu 24.4.5, do a manual call to that remote node. The messages will show you whether the call is successful. If the call fails, verify the telephone number(s) in Menu 11.
	If the call is successful, but the call still terminates, then it must be a PPP negotiation problem. Verify the following parameters in Menu 11: My Login, My Password, Route, IP LAN Addr. Also verify your IP address in Menu 3.2.
	Check the error log in Menu 24.3.1, this will usually give you hints of why that call was dropped. If there is nothing in the log, the call may have been dropped by the remote device. Make sure that the configurations on the two devices are consistent.

11.5 Problems with Remote User Dial-in

Table 11-5. Troubleshooting Remote User Dial-in

Symptoms	Corrective Action
Remote User Cannot dial in	Verify the dial-in user has the correct login name and password
	Verify that the IP address is specified correctly in Menu 13. Check that either the dial-in supplying a valid IP address, or that the <i>Prestige</i> is assigning a valid address from the IP pool.

Index

- 10Base-T, xv, 1-4, 1-6, 2-2, 2-4

- Active field, 3-13
- Asynchronous, 1-3

- Backup Configuration, 10-12
- Backup ISP Account, 3-12
- Baud Rate, 10-5
- Branch Office, 1-8

- Call Control
 - blacklist, 10-16, 10-17
 - budget management, 10-16, 10-18
- Call Control Parameters, 2-14, 2-16
- Callback
 - budget, 6-6
 - field, 6-6, 6-7
- CDR, 10-7, 10-8
- CHAP, 1-2, 1-9, 4-4, 6-5
- CLID, 2-15, 4-3, 6-5, 6-10, 10-8
- Client, 3-4, 3-6, 6-1
- Connecting
 - computer and VT100 terminal, 2-4
 - power adapter, 2-4
 - Prestige 100WH*, 2-3
- Corporate Office, 1-8

- DHCP, 1-2, 3-2, 3-3, 3-4, 3-5, 3-6, 3-12
- Dial On Demand, 4-1
- Dial-in
 - default dial-in setup, 2-8, 6-4, 6-5, 6-6, 6-7
 - users setup, 6-5
- Dial-in Server, 6-1
- Dial-in User, 2-8, 6-1, 6-5, 6-6, 6-8, 6-9, 6-10
- DNS, 3-4, 3-6, 3-7, 10-4

- Ethernet
 - setup, 2-8, 3-1, 3-2, 3-5, 3-6

- Filtering, 7-1, 7-2
 - call filter, 4-5, 7-1
 - filter rules, 7-2, 7-4, 7-5, 7-6, 7-9, 7-11
 - filter type, 7-5, 7-6
 - filters sets, 3-2, 4-5, 6-7, 7-1, 7-2, 7-3
- Firmware, 10-13, 10-14
- FTP, vi, 3-4, 3-8

- Gateway IP Address, 5-8

- IANA, 3-4
- ICMP, 3-10, 10-4, 10-10
- Idle Timeout, 4-6, 6-7
- Internet
 - Internet Access, 1, ii, xv, 1-1, 1-7, 2-1, 2-3, 2-5, 2-8, 3-1, 3-7, 3-8, 3-11, 5-4
 - ISP, 3-2, 3-4, 3-6, 3-7, 3-8, 3-9, 3-10, 3-12, 3-13, 3-14, 7-1, 10-10, 11-3
- Internet Connection
 - test, 2-8, 3-9, 3-12
- IP Address, 3-2, 3-3, 3-4, 3-6, 3-7, 3-8, 3-13, 5-3, 5-4, 5-5, 5-8, 6-6, 7-8, 10-7
- IP Pool, 3-4, 3-6, 6-6
- IP Subnet Mask, 3-6, 5-4, 5-8
- IPCP, 5-5, 10-8, 10-11
- ISDN TA, 1-1, 1-3, 2-13, 2-15

- LAN-to-LAN
 - applications, xv, xvi, 1-1, 1-7, 1-8, 5-3
- Login
 - name, 3-7, 3-8, 4-4

- Manual Call, 10-10, 10-11
- Metric, 5-4, 5-8
- Modem
 - external modem, 1-1

- NAT, 1-2, 3-10

- PAP, 1-2, 1-9, 4-4, 6-5
- Password, 1-2, 2-6, 2-8, 2-9, 3-7, 3-8, 3-14, 4-3, 4-4, 6-5, 6-9, 8-1, 11-3
- Phone Number
 - pri(mary), 3-8
 - sec(ondary), 3-8, 4-4
- Power Adapter, 2-1, 2-4
- PPP, 1-2, 1-3, 3-14, 4-5, 4-7, 6-5, 6-9, 10-10, 11-3
- PPP Options, 4-5, 4-7, 6-5
- Primary ISP, 3-13
- PSTN
 - initialization, 2-5, 2-13

- RAS, 10-4, 10-13, 10-14
- Remote Node
 - configuration, 4-1, 6-3
 - network layer options, 5-2, 5-3, 5-4, 5-5
 - profile, 4-1, 4-2, 4-3, 4-4, 4-5, 4-6, 4-7, 5-2, 5-3
 - setup, 2-8, 4-1, 5-2
- RIP, 3-3, 3-6, 3-13, 4-6, 5-4, 5-5, 5-6, 7-1
 - direction, 3-3, 3-6
- RJ-45 cable, 1-6, 2-4
- ROM, vi, 10-12, 10-13, 10-15
- Routing, 5-8, 7-8, 11-3
- RS-232 cable, iii, 2-4

- Server, 1-1, 1-9, 2-8, 3-3, 3-4, 3-6, 3-7, 3-8, 3-10, 3-12, 3-14, 3-15, 5-4, 6-1, 6-3, 6-10, 10-7
- SMT, xv, 2-6, 2-7, 2-8, 3-7, 3-9
- Static Route, 5-6, 5-7
 - IP static route, 5-7, 5-8
 - setup, 5-6, 5-7
- SUA, 1-2, 1-7, 3-9, 3-10, 3-11, 3-12
- Subnet Mask, 3-2, 3-4, 3-5, 3-6, 3-13, 5-4, 5-5, 5-8, 11-2
- Subnetwork
 - Class C, 3-2
- System Maintenance, 2-8, 10-1, 10-2, 10-3, 10-4, 10-5, 10-6, 10-7, 10-9, 10-10, 10-12, 10-13, 10-15, 10-16
 - diagnostic, 10-9, 10-10
 - system status, 10-2
- System Management Terminal, xv, 2-6, 2-7, 2-8

- TCP/IP
 - configuration, 5-1, 5-4, 5-5
- Telco Options, 4-5, 6-5
- Telecommuting, xvi, 1-9, 6-1
 - telecommuter, 6-2
- Telnet
 - configuration, 2-4, 9-1
- Troubleshooting
 - connecting, 11-3
 - LAN interface, 11-2
 - starting up, 11-1
 - WAN port connection, 11-2

- UDP, 3-10, 7-8
- UNIX, 5-4, 10-7
- UTP, 2-4

- WAN Port Setup, 2-12, 2-13, 2-14, 2-15

- XMODEM, 10-12, 10-14, 10-15

- ZyXEL
 - Support Group, 10-16
 - Website, vi